

FD series

Inverter Packaged Air-Conditioners

High Performance
Air-Conditioning

2019



CE

50/60Hz

19P01E



High Performance Air-Conditioning FDseries

The PAC range from Mitsubishi Heavy Industries Thermal systems is ideal for air conditioning offices, shops, restaurants, and bars ... as well as other commercial environments. The versatility of the PAC range, offers you a wide selection of models in function of your installation needs. The modern and attractive design of our indoor units is harmoniously integrated in the any atmosphere creating a pleasant and relaxing environment.

CONTENTS

PRODUCT INFORMATION	page 4
PRODUCT LINE UP	page 20
BENEFITS SUMMARY	page 24
PRODUCT SERIES	page 26
CONTROL SYSTEMS	page 66
OUTDOOR UNIT DIMENSIONS	page 70
ENERGY EFFICIENT AND ENVIRONMENTALLY CONSCIOUS	page 74



New Generation FDT



Automatic energy saving control

Keep maximum comfort with minimal draft

Quiet operation

High energy efficiency with new technology

New FDT can achieve higher seasonal efficiency by Mitsubishi Heavy Industries latest technology.

● SEER and SCOP is defined in European regulations. Please refer to P74.

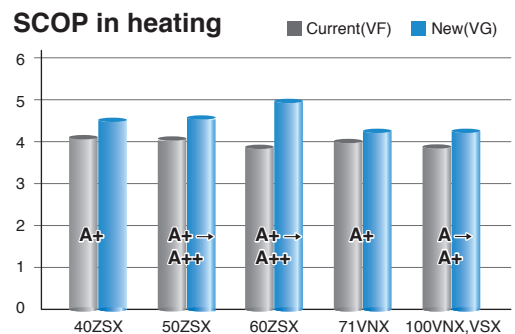
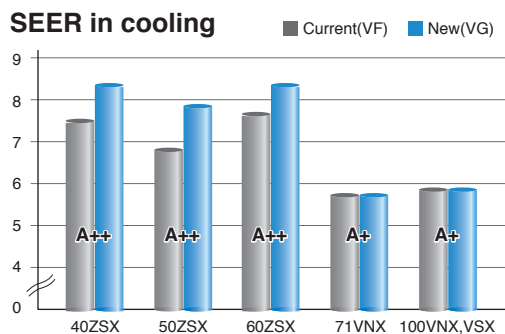

More quiet noise & Improve the aerodynamic performance of the unit

New technology has realised quiet noise with keeping capacity and comfort. A low noise is achieved by reducing the pressure fluctuation in an indoor unit. A fan guard attains both safety and quietness by flow.

New design turbo fan

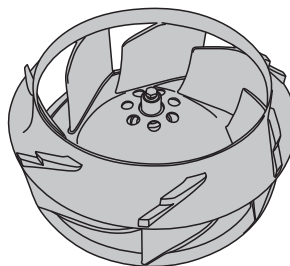

Fan guard (standard equipment)



Flexible flap control for draft prevention. Brand new function in the market



Draft Prevention Panel (Option)

4 additional flaps are to be controlled individually at each operation mode. They change air flow direction and prevents draft feeling. This new function also achieve more flexible control for air flow direction.



Motion Sensor (Option)

New motion sensor (option) detects human activity. Energy saving control is achieved by shifting set temperature according to detected amount of activity.

New Generation FDTC

More comfort and More energy saving

New European Design

Lower noise



European design & Flat panel

Thin Panel

FDTC thin panel fit within 10mm from the ceiling.

Unique Grille Design

Honeycomb grille



Compact Design

□700mm → □620mm

A weight of only 14kg. Height of thin panel and main body is only 248 mm allowing it to be a very easy installation.

Big Louver

Improved directionally

Integrated ceiling system design



More quiet operation

Adopting new turbo fan and improving new heat exchanger enable to reduce noise.

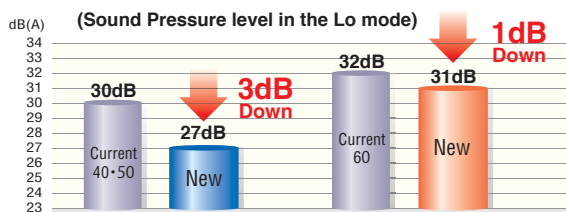

Draft Prevention Panel and Motion Sensor (option)



It is available to set draft prevention panel and motion sensor as well as FDT.



Ceiling cassette
FDT-VG series



Ceiling cassette Compact
FDTC-VG series

Draft Prevention Panel

Keep maximum comfort with minimal draft:
New FDT & FDTC control flaps with more flexibility.



The Good Design Award is Japan's only comprehensive design evaluation and recommendation initiative, originating with the "Good Design Products Selection System" founded in 1957. It is now a global design award with participation from numerous Japanese and international companies and organizations. The "G Mark", the symbol of the Good Design Award, is known widely as a symbol of excellent design.

(FDT)

Draft Prevention Panel Operating Image

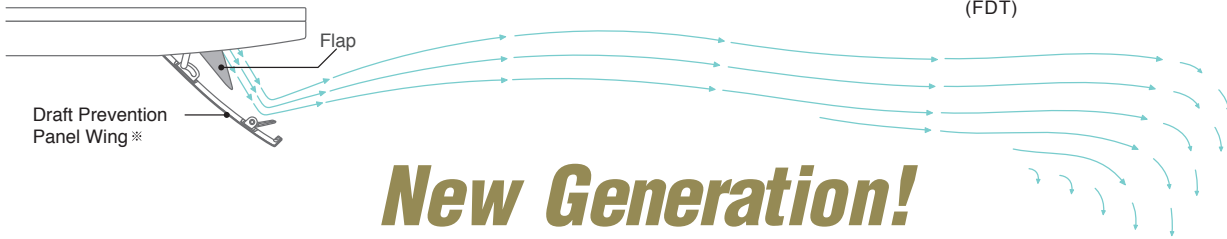

New Generation!

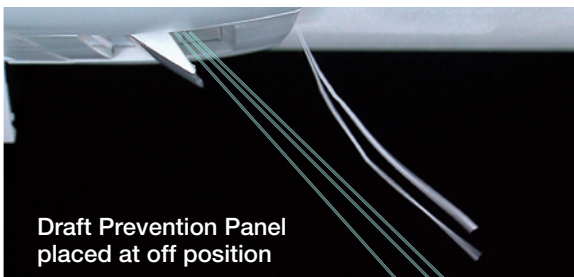
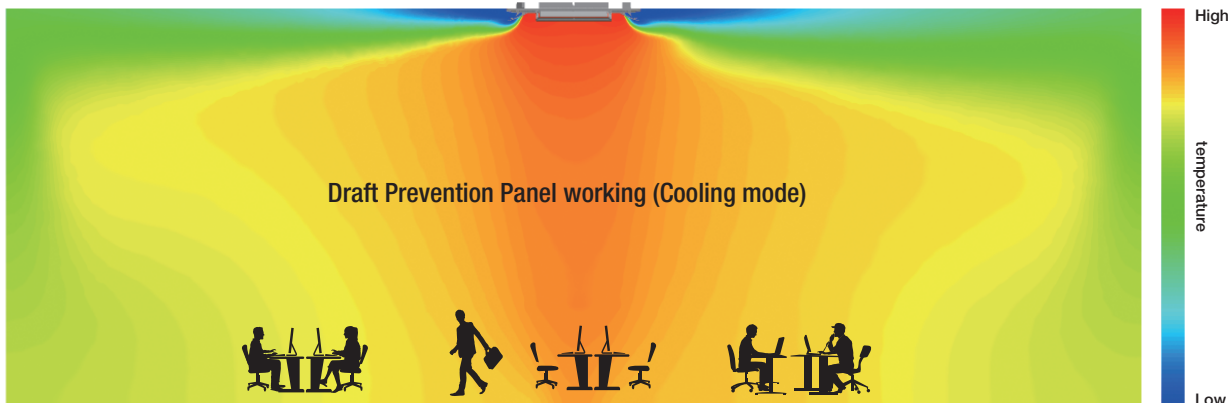

Draft Prevention Panel placed at off position

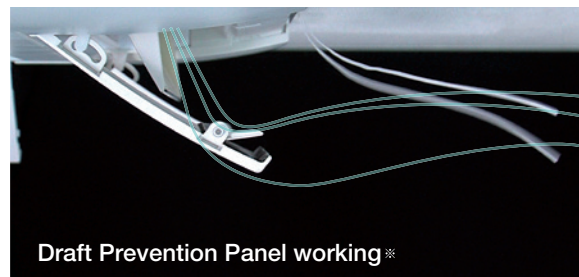

Draft Prevention Panel working

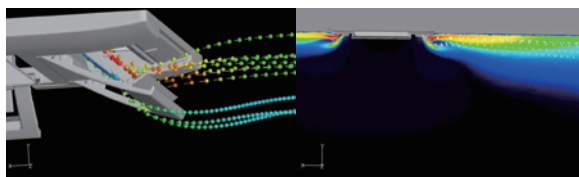
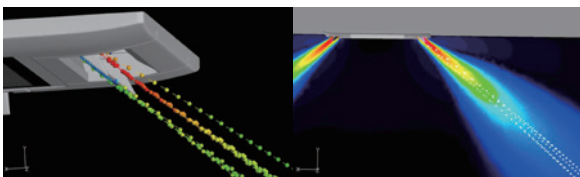

Draft Prevention Panel provides a comfortable airflow without any draft feeling. Whether cooling or heating a room, the remote control can be used to instantly suppress any warm or cool drafts. This accurately assists how air flow is directed out of the indoor unit.

※ These are images of FDT. The panel structure of FDTC slightly differ from FDT.

Motion sensor

Energy saving control by detecting human moving

User



3 Step Control

Power Control

New motion sensor (option) detects human activity. Energy saving control is achieved by shift set temperature according to detected amount of activity.

Stand by

Unit will go on stand-by mode when no activity is detected. When unit will detect activity again, unit will re-start operation automatically.

Auto Off

Unit will go off automatically when no activity is detected for 12 hours.

[temperature]

26°C

in cooling

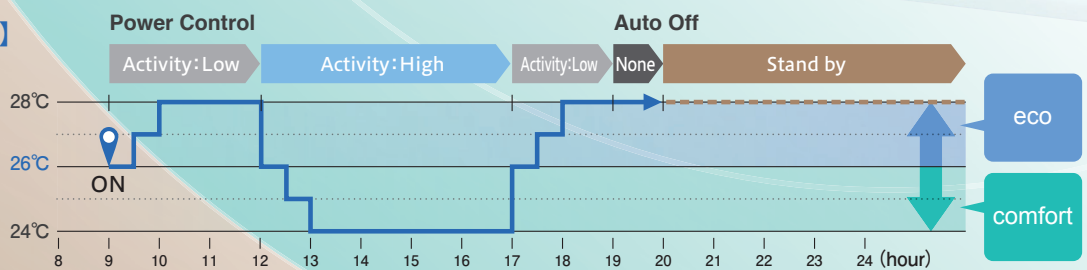

[temperature]

22°C

in heating

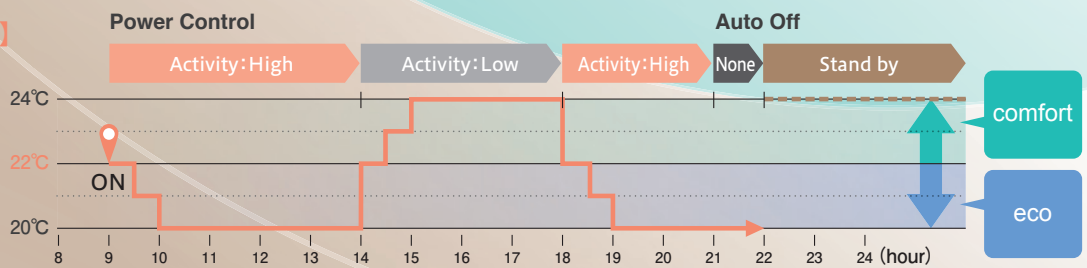

<p>Power Control Increased energy savings</p> <p>Low human activity</p>	<p>Power Control Increased comfort</p> <p>High human activity</p>	<p>Stand by Operation stops temporarily</p> <p>Absence for 1 hour</p>	<p>Auto off Operation stops completely</p> <p>More 12 hours absence</p>
--	--	--	--

Operation mode and Control of Motion sensor

eco operation
comfort operation

Operation mode

	Human activity	Operation mode				
		Auto	Cool	Heat	Dry	Fan
Power Control ※1	Low	Cooling +2°C	+2°C	+2°C	—	—
		Heating +2°C	+2°C	+2°C	—	—
	High	Cooling -2°C	-2°C	-2°C	—	—
		Heating -2°C	-2°C	-2°C	—	—
Auto Off ※2		●	●	●	●	●

※1 Set temperature is revised maximum 2°C at Cooling/Heating mode by detecting heat volume movement.
 ※2 Absence for 1 hour ⇒ Operation stops ("Stand-by") More 12 hours absence ⇒ Operation stops completely

Serviceability & workability

Easy and quick installation and maintenance

Builder Maintenance



Quick positioning!

Indoor unit is easily positioned and installed

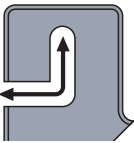
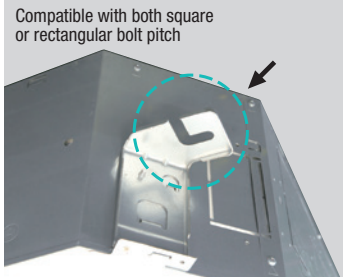
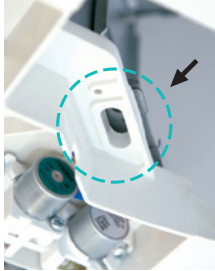
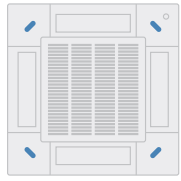
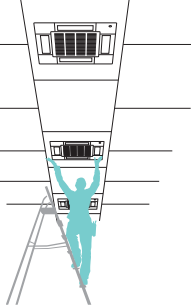
<p>1 Adjustable easier positioning of unit by new slits FDT</p> <p>New shape of slit is suitable to install the unit with more flexibility, according to many kinds of suspending bolt pitch on site. Any rectangular or squared pitch of suspending bolts are available with this slit.</p>  	<p>2 New slit in panel allows easier installation on site. FDT FDC</p> <p>Flexible positioning is available, which helps adjusting the direction of panel according to lines or pattern on the ceiling.</p>   
--	--

Quick installation and maintenance

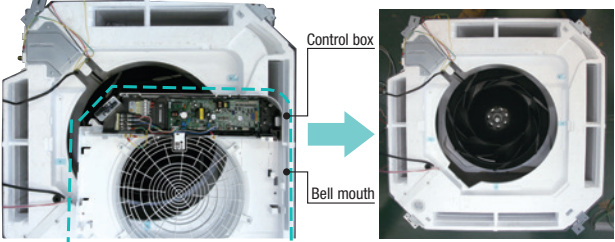
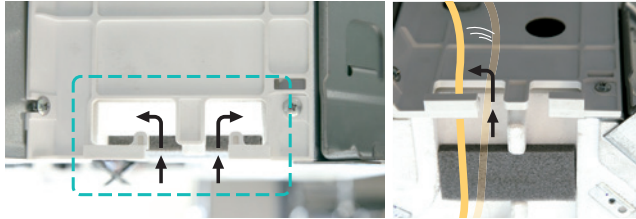
<p>1 Easy access to component part for easy maintenance. FDT</p> <p>1 The control box and bell mouth can be removed together. 2 Easy access to impeller and fan motor.</p> 	<p>2 New shape of path of wiring FDT</p> <p>New shape of path gives easy wiring work for installation.</p> 
--	---

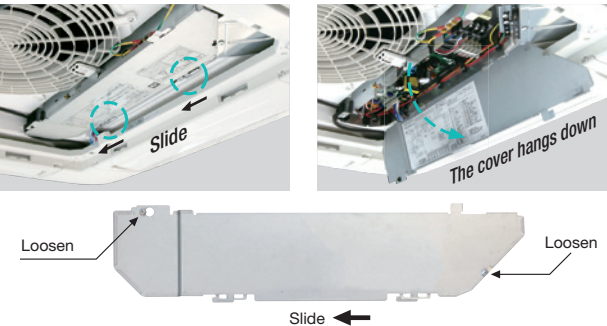
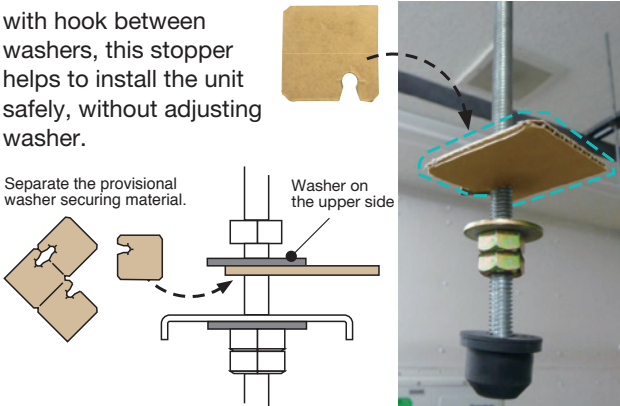
<p>3 No need to remove screws to take off the controller cover. FDT</p> <p>It is possible to loose and slide open the cover without remove of the screws. This prevents the cover from falling and damaging to stuffs on site.</p> 	<p>4 More safe installation by stopper of washer FDT FDC</p> <p>When unit is installed with hook between washers, this stopper helps to install the unit safely, without adjusting washer.</p> 
--	---





Builder Maintenance

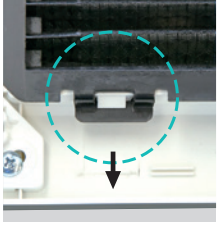
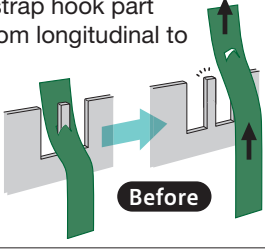
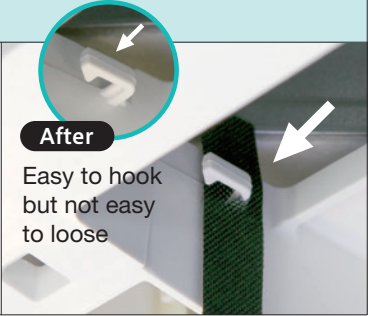
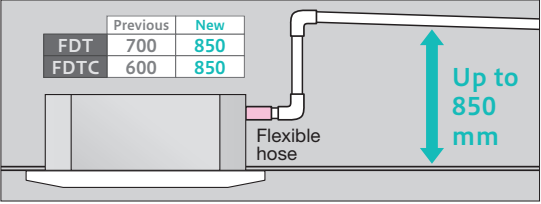
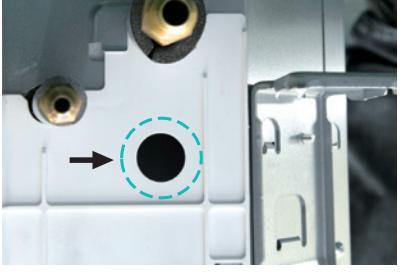
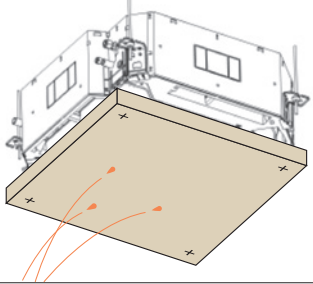

For smooth and easy working

Good help for installation and maintenance

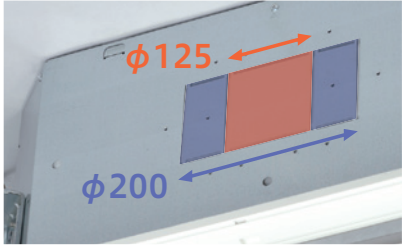
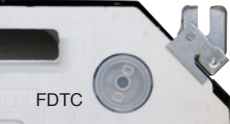
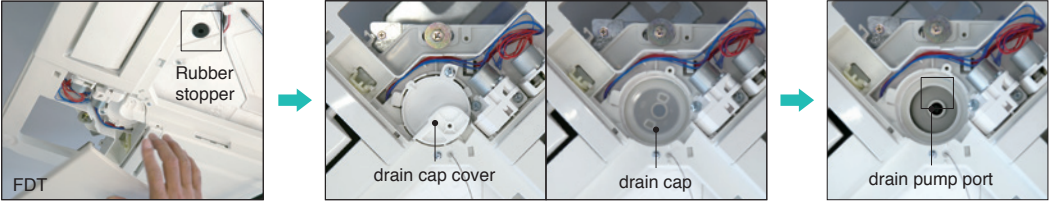
<p>1 Easy and flexible hook to remove the filter FDT FDTC</p>	<p>2 Securely fix the corner lid by strap FDT</p>									
<p>Hook of soft material helps to remove the filter without dust spreading.</p> <p>Press the filter tab to the outside and remove the filter.</p> 	<p>The direction of the strap hook part has been changed from longitudinal to lateral. Furthermore, a barb has been added to the hook pin to prevent the strap from coming off.</p>   <p>After Easy to hook but not easy to loose</p>									
<p>3 Drain-up-lift increases up to 850 mm FDT FDTC</p>	<p>4 New port to check drain water flow FDT</p>									
<p>The drain can be lifted up to 850 mm from the ceiling surface.</p> <table border="1" data-bbox="172 967 421 1048"> <thead> <tr> <th></th> <th>Previous</th> <th>New</th> </tr> </thead> <tbody> <tr> <td>FDT</td> <td>700</td> <td>850</td> </tr> <tr> <td>FDTC</td> <td>600</td> <td>850</td> </tr> </tbody> </table>  <p>Up to 850 mm</p>		Previous	New	FDT	700	850	FDTC	600	850	<p>A water supply port has been provided in the piping lid for easier testing of the drain water flow. (The port is usually sealed with a rubber cap.)</p> 
	Previous	New								
FDT	700	850								
FDTC	600	850								
<p>5 Re-use of packages during construction work FDT FDTC</p>	<p>6 More flexible outlet for ducting FDT FDTC</p>									
<p>Package material (carton) help to protect the unit from unexpected welding spatter or coming dust to the new unit.</p> 	<p>Both $\phi 125$ and $\phi 200$ (oval shaped) are available.</p>  									
<p>7 Easy check of drain pan FDT FDTC</p>										
<p>Easy check of drain pan condition is available by removing corner lid only.</p> 	 <p>Remove corner lid. Remove drain cap cover and check the condition. It is necessary to clean-up, firstly remove the rubber stopper to drain water out and secondly remove the drain cap.</p> <p>Clean up the area around the drain pump port.</p>									



*Simple use with advanced settings **REMOTE CONTROL***

Easy touch and Easy view with full dot Liquid Crystal display

Add new function

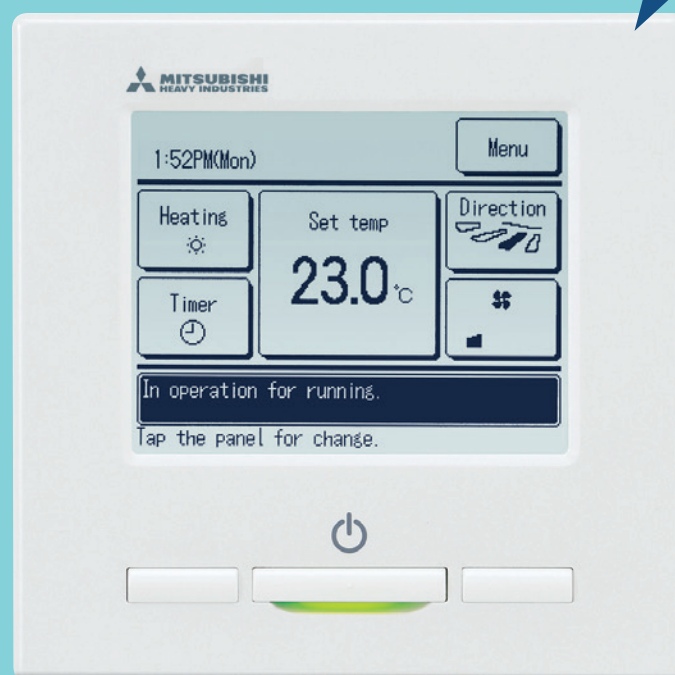

RC-EX3A

Functions

Function Switch

The function switch allows you to select and set two functions that you desire among the six available functions shown.

These functions can be used by simply pressing the button after they are set, allowing you to use your preferable functions immediately.

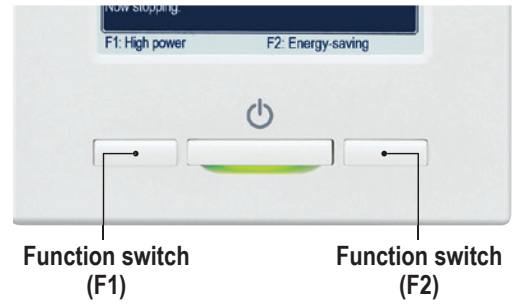

15 min 1 High Power Mode

High Power Mode achieve excessive cooling / heating capacity for 15 minutes to quickly adjust the room temperature to a comfortable level.

2 Energy Saving Mode

Temperature is set to optimized to save energy without losing comfort.

3 Quiet Mode

Outdoor unit starts to operate quietly by activating this mode. The time of this mode can be set in conjunction with Indoor Silent Timer.

4 Home Leave Mode

Home leave mode maintains the room temperature at a moderate level.

5 Favorite Mode

Operation mode, set temperature, fan speed and air flow direction are automatically adjusted to the programmed favorite setting.

Now 6 Filter Sign

Announces the due time for cleaning the air filter.

NEW

7 Anti draft ON/OFF

Anti draft can be turned ON/OFF with a single tap of the button.

Favorite Mode

Operation mode, set temperature, fan speed and air flow direction are memorized and allocated to two buttons that can be operated by one touch.

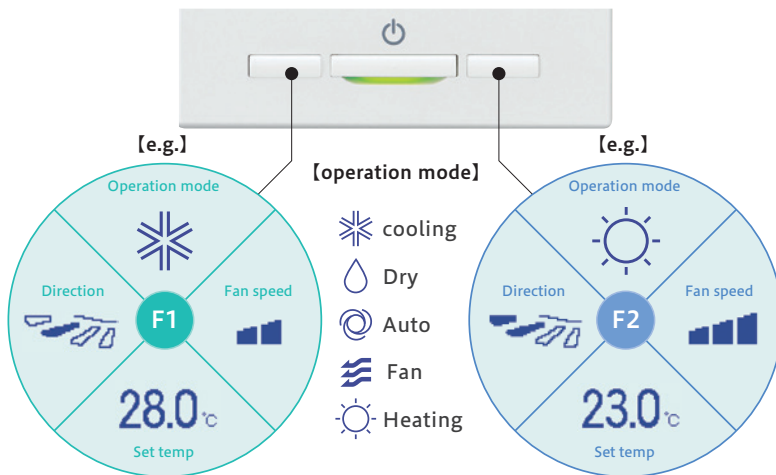

Adjusting Brightness of the Operation lamp

The brightness of the operation lamp behind Run/Stop switch can be adjusted by 10 stages.



Draft prevention setting (only FDT-FDTC series)

User can enable/disable the motion of panel with anti draft for each blow outlet for each operation mode. This function can be set while operating. **NEW**

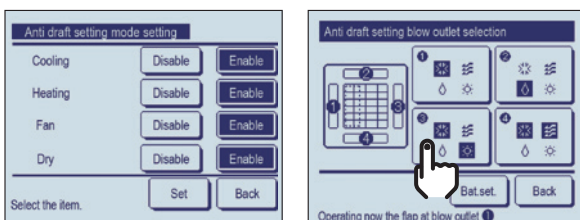

Easy modification of Air Flow

User can visually confirm and set the direction of louvres using the visual display on the remote controller.

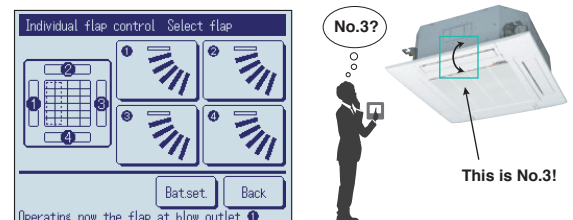

Motion sensor control

Presence of humans and the amount of motion are detected by a motion sensor to perform various controls.

- 1 Select Enable / Disable
Motion sensor control



Enable / Disable

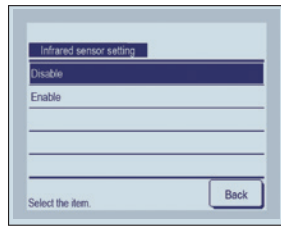

Select [Enable] / [Disable] for the motion sensor of the indoor unit connected to the R/C.

- 2 Select Enable / Disable per control

- Power control
- Auto-off

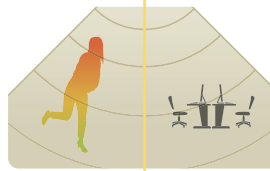

Enable / Disable

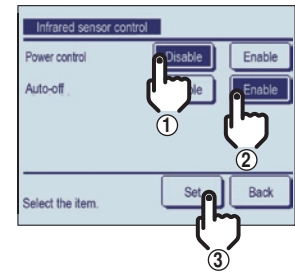

Backup Control

Control restricted to two indoor units (two groups)



Fault backup control



Keep back up all the time!

If one of the two indoor units malfunctions and stops its operation, the other starts backup operation so that users' comfort will not be compromised.

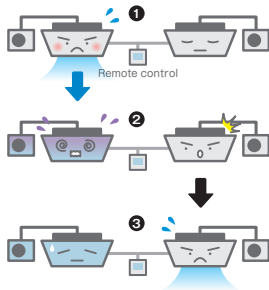

Capacity backup control



Maintains users' comfort!

When the control system detects either of two units is operating with overload, the other unit cover the capacity.

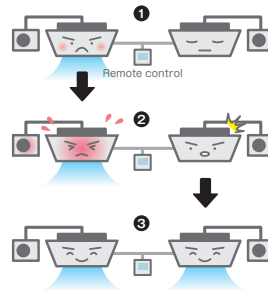

Rotational operation control



Energy saving and longer life!

By operating two indoor units alternately, their chronological changes are equalized. (The alternate operation cycle can be specified in a range from 10 hours to 990 hours in increments of 10 hours.)

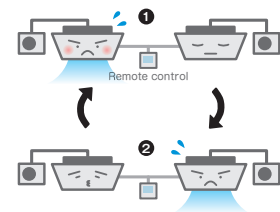

Additional functions of External Input / Output

The external input/output of indoor unit by remote controller can set input/output based on user's demand.



Remote surveillance system



Card key on-off

External Input

CNT (1-6) CNTA (1-2)	
Input	On/Off Permission/Prohibition Cooling/Heating Emergency Stop
Newly added	Set temp. shift Forced thermo-off IU operation stop Silent mode

External Output

CNT (New)	
2 Output	- Operation - Heating - Compressor ON (thermo-ON)
3 Output	- Inspection
4 Output	- Cooling (defrosting) - Fan operation - Fan operation with Phi or Hi - Fan operation with Me or Lo - Defrosting (oil return in heating operation) - Ventilation
5 Output	- Heater ON - Free cooling - IU overload alarm

Silent mode control

The Outdoor unit is controlled with priority on quietness. Silent mode control must be set to the F1 or F2 switch. User can start/stop the silent mode control with a single tap of a button.

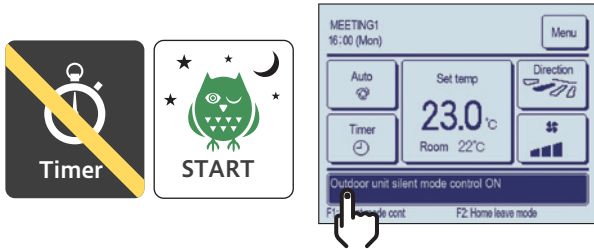

Language Switching

User can select from the following languages and also switch them on the top display. **NEW**



Indoor unit capacity display

Capacities of Indoor units connected to the RC-EX3A are displayed.

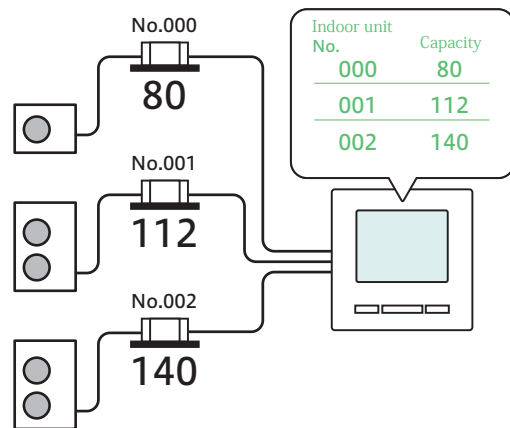
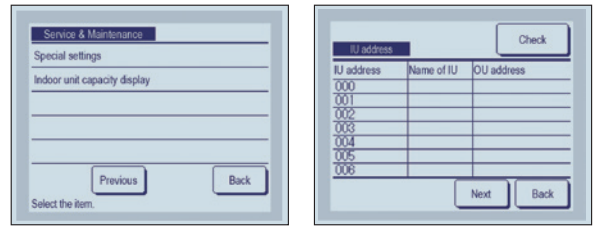

Contact company & Error display

If any error occurs on the air conditioner, the "Unit protection stop" is indicated on the message display.

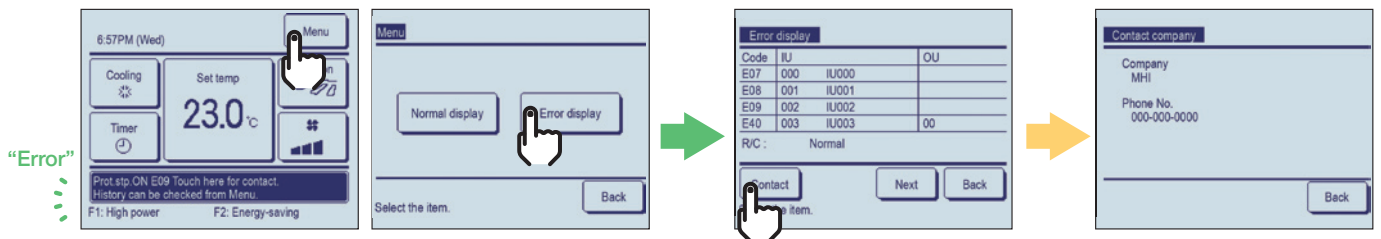

Wireless Kit & Wireless Remote Controller

Line-up

Model	Wireless kit
FDT	RCN-T-5AW-E2
FDTC	RCN-TC-5AW-E2
FDE	RCN-E-E3
FDU	RCN-KIT4-E2
FDUM	
FDF	

Function added

- 1) High power
- 2) Energy-saving
- 3) ON/OFF Timer by clock
- 4) Child lock
- 5) Silent mode control for Outdoor unit
- 6) Home leave mode

The functions and the operations will be improved.



Display

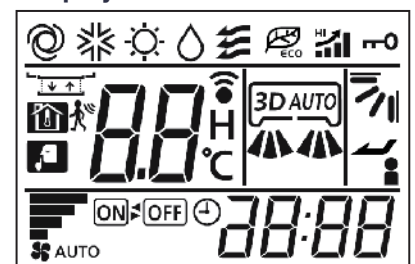

Hyper Inverter

Our new advanced technology has high efficiency, strong heating and long piping. This contributes to the environmental protection through energy saving and permits installation of the units (4~6HP) considering a heating operation under temperature conditions down to -20°C and design flexibility has been improved by extension of piping length to 100m.

Line up

HP	1.5	2	2.5	3	3.5	4	5	6	8	10
Hyper Inverter	●	●	●	●	-	●	●	●	-	-



SRC40ZSX-S (1.5HP)
SRC50ZSX-S (2.0HP)
SRC60ZSX-S (2.5HP)



FDC71VNX (3.0HP)



FDC100VNX/VSX (4.0HP)
FDC125VNX/VSX (5.0HP)
FDC140VNX/VSX (6.0HP)



High efficiency (comparison of FDT series)

Hyper inverter outdoor units high efficiency levels are achieved by our latest technologies, such as high efficient twin rotary compressors.

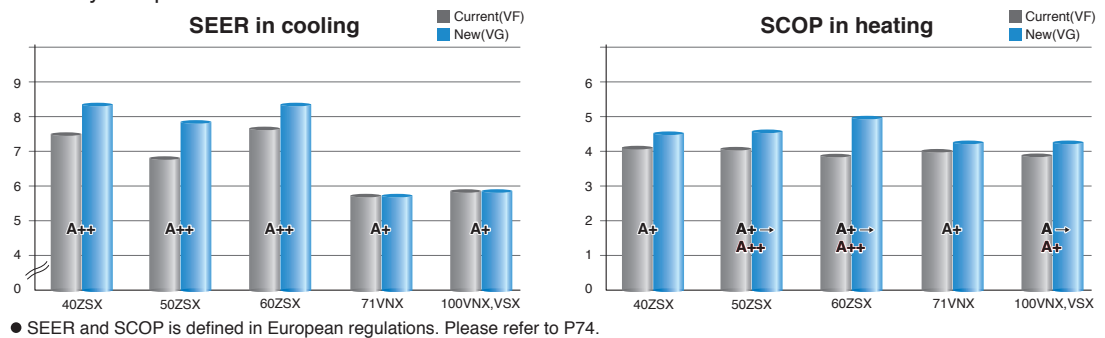

Wide Range of Operation

Our new advanced technology has expanded the heating and cooling operation range. This permits installation of the units considering a heating and cooling operation under a low temperature condition down to -20°C .

FDC71/100/125/140

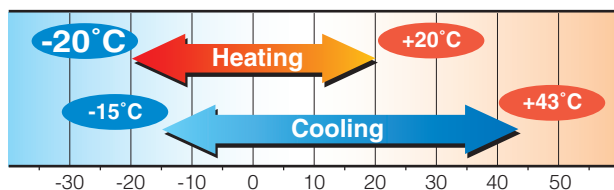

SRC40/50/60

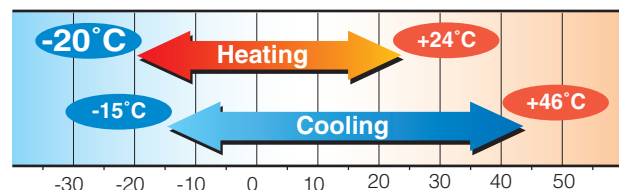

Max. heating capacity (kW)

	Hyper Inverter	Micro Inverter
FDC100VSX(4HP, 3Phase 380V)	16.0	12.5
FDC125VSX(5HP, 3Phase 380V)	18.0	16.0
FDC140VSX(6HP, 3Phase 380V)	20.0	16.5

Leading powerful heating capacity in the industry

Thanks to optimization of refrigeration control with use of electric expansion valve and development of twin rotary compressors, max heating capacity has been increased.

Hyper Inverter series can reach the set temperature very quickly, keeping nominal heating capacity when outdoor temperature is -15°C . It is effective to be used even in cold area.

Temperature of supply air can reach 40°C in 4 minutes after start up under low temperature operation conditions (at both indoor and outdoor temperature of 2°C) and can reach 50°C in 8 minutes after that.

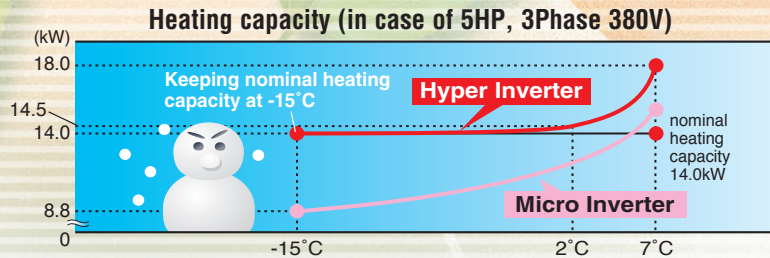

model name	nominal heating capacity (kW at outdoor temperature of 7°C)	heating capacity at outdoor temperature of -15°C
FDC100VSX(4HP, 3Phase 380V)	11.2kW	11.2kW
FDC125VSX(5HP, 3Phase 380V)	14.0kW	14.0kW
FDC140VSX(6HP, 3Phase 380V)	16.0kW	16.0kW

Please refer to our technical manual for installation conditions, operation range and heating/cooling capacities. (including 1Phase 220V)

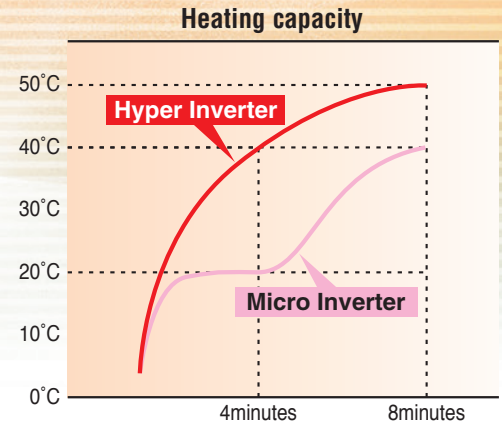

Heat exchanger (All outdoor units)

Thanks to changing fin configuration from flat sheet to M shape fin. This high dimensional structure provides optimum balance of heat transfer and airflow.

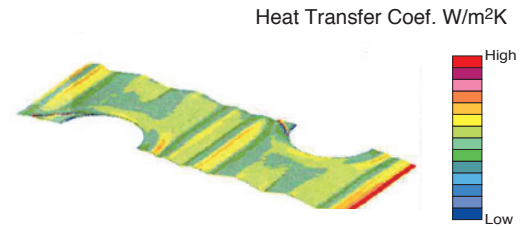
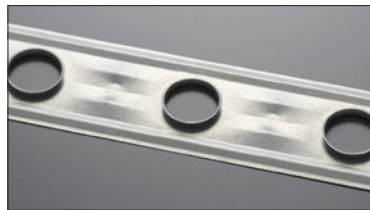

Installation workability

Enhanced installation workability thanks to the extended pipe length – longest level in the industry and precharged refrigerant.

Long Piping

(in case of 4~6HP)

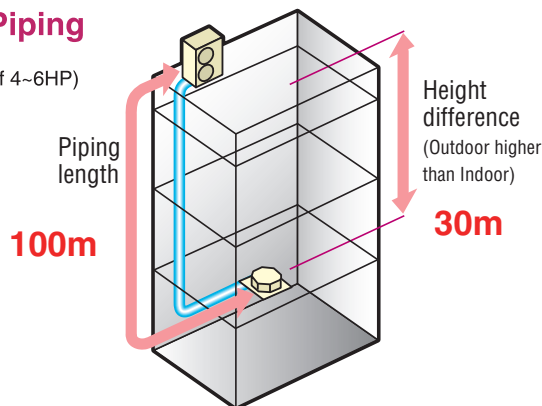

Refrigerant precharged piping length extending to 30m

Refrigerant precharged piping length extends up to 30m. This eliminates the need to add refrigerant on site, which sets it free from trouble of excessive or insufficient charging of refrigerant, and allows carrying out the installation smoothly.

* Hyper inverter 1.5~2.5HP is up to 15m.

Easy Transportation & Installation

Fits into elevators

Eazy installation

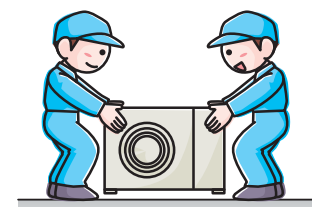

HP	Piping length	Height difference
1.5~2.5	30m	20m
3	50m	30m
4~6	100m	30m

Micro Inverter

Line up

HP	1.5	2	2.5	3	3.5	4	5	6	8	10
Micro Inverter	-	-	-	-	-	●	●	●	●	●



Size reduction and high efficiency performance on the DC twin rotary compressors (Micro Inverter 4-6HP)

Employment of DC twin rotary compressor has enabled to utilize a high-speed range of up to 120 rps at the maximum to secure the required capacity. Optimum compressor control has been realized by employing the vector control* and the starting current has been improved significantly compared with former models. Moreover, vibration has been reduced.

Former compressor
Height at 440 mm
Outside diameter of shell ø185mm

DC twin rotary compressor
Height at 342mm
ø133mm

Reduction in height by 22.3%
Reduction in volume by 44.1%

* Vector control means a technique to realize an optimum control by converting the current wave to a smooth sinusoidal waveform

Better partial load efficiency

Distributed winding motor → **Centralized winding motor**

Wide range of operation

Our new advanced technology has expanded the heating and cooling operation range. This permits installation of the units under a low outdoor temperature conditions down to -15°C/-20°C in heating operation and -15°C in cooling operation.

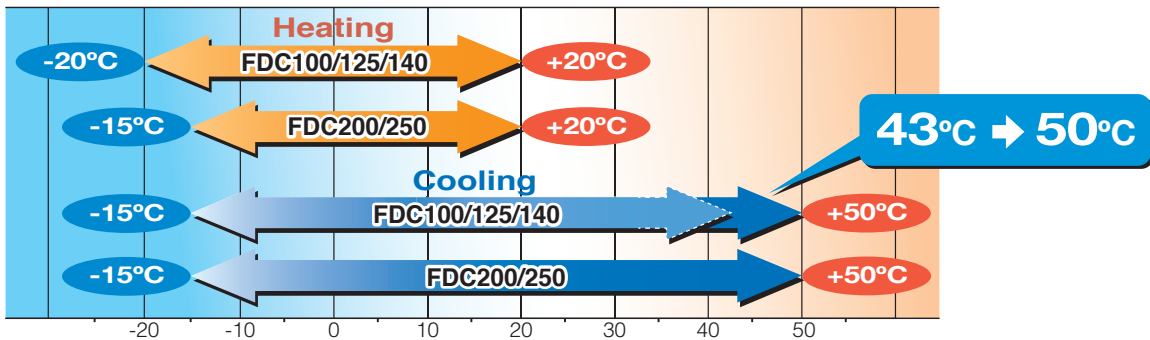

Higher seasonal efficiency

Seasonal efficiency is improved by use of centralized winding motor.

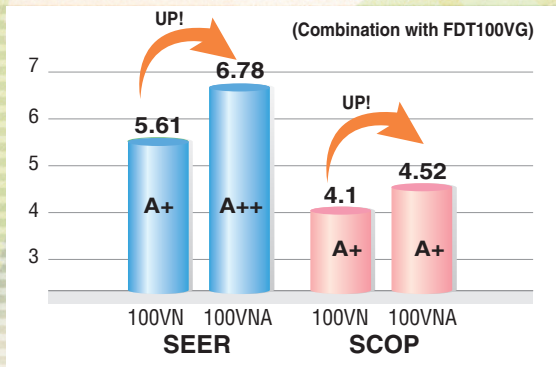

* Please refer to P74

Long Piping Length

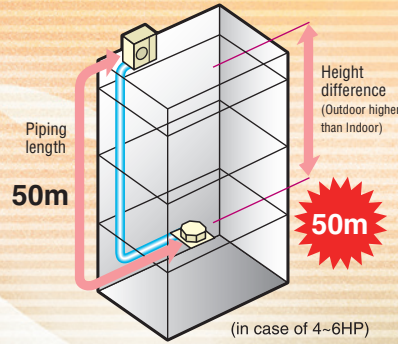

The industry's first!

HP	Piping length	Height difference
4~6	50m	50m*
8~10	70m	30m

*When the outdoor unit is installed at a position higher than the indoor unit by 30m or more, set SW5-2 on the control PCB to ON.

Silent mode

More quiet "silent mode" is possible.

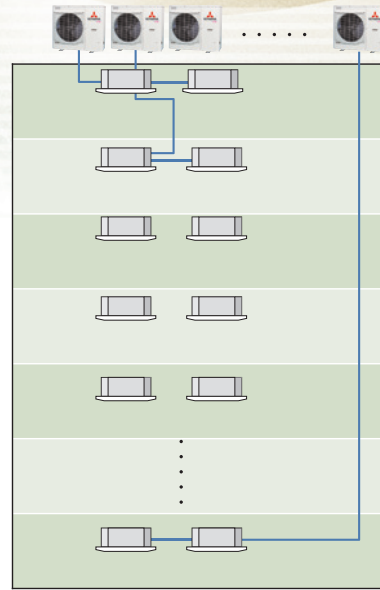
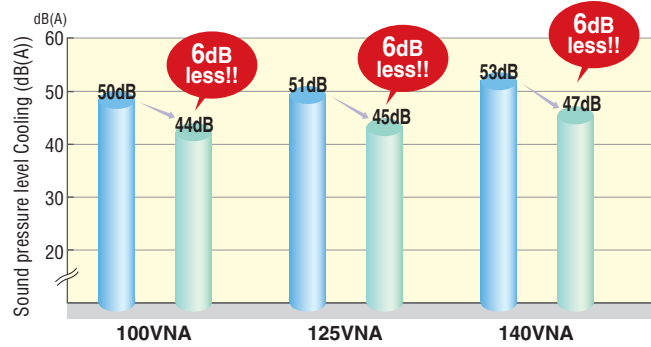

Wider variation of installation!

Serviceability (Micro Inverter 10HP)

● Improved freedom of piping layout

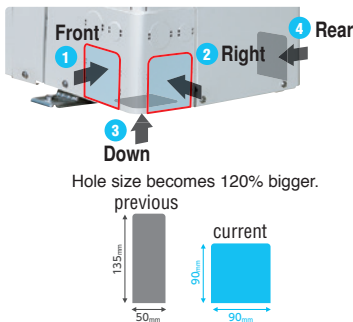

● Wire insertion holes for fall prevention



● 2 Layer Construction

Thanks to control box structure with 2 layer construction using hinge connection, service and maintenance has been made much easier for inverter components.



● Four handles

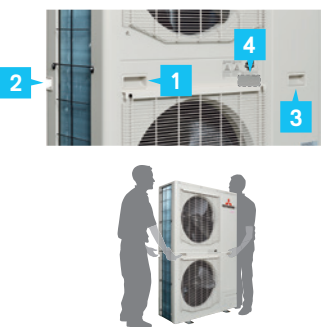

Located at the same level for easy transport and transfer.

● A transparent rain cover



Attached as a standard for easy maintenance.

● Fixing screws to service panel

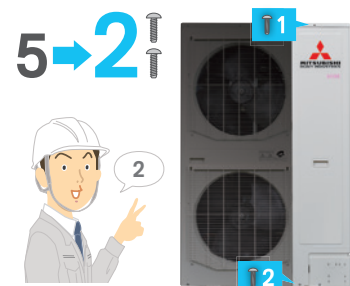

Decreasing number of screws from 5 to 2, installation & service speed is improved.

Standard Inverter

Line up

HP	1.5	2	2.5	3	3.5	4	5	6	8	10
Standard Inverter	-	-	-	●	●	●	-	-	-	-



FDC71VNP (3.0HP)



FDC90VNP1 (3.5HP)



FDC100VNP (4.0HP)

Blue Fin

Blue Fin

Compact Design of outdoor units

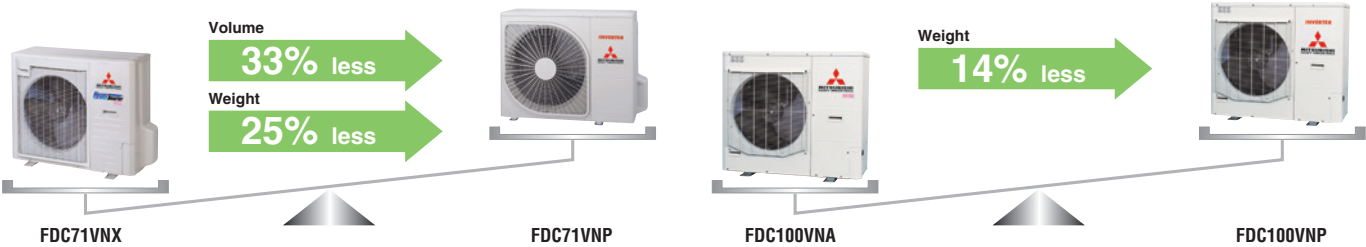

High SEER & SCOP

Though the seasonal efficiency is lower than that of Hyper inverter, higher SEER & SCOP are achieved by optimizing control.

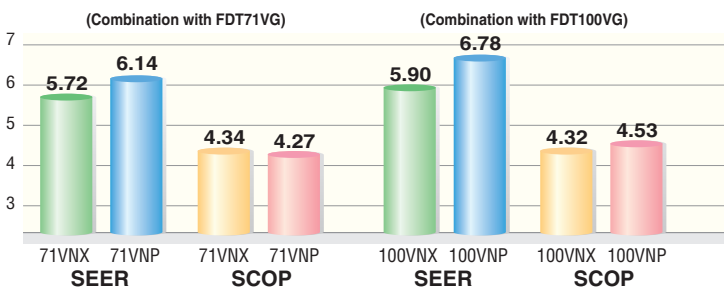

※ Please refer to P74

Installation workability

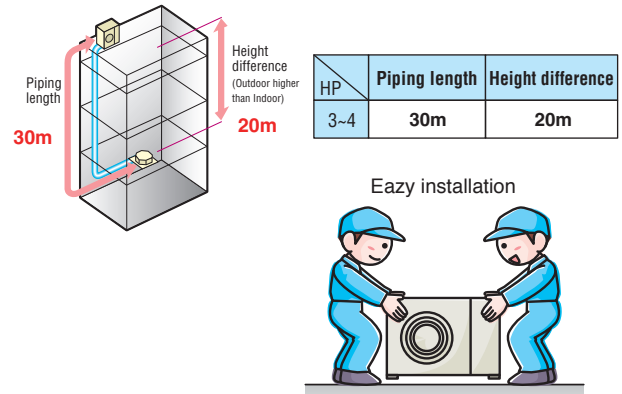

Point 1 Blue Fin

Due to application of blue coated fins (KS101) for the heat exchanger of new outdoor unit, corrosion resistance has been improved compared to current models.

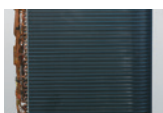

Blue Fin

Hyper Inverter 3~6HP
Micro Inverter 4~10HP
Standard Inverter 3.5, 4HP

Point 2 Monitoring Function (All series)

To your PC monitoring and service tasks made simple with our service software ("Mente PC").

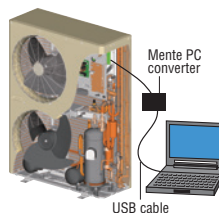

Point 3 Base heater kit (option)

This kit is recommended to be used in an area where the lowest temperature drops below 0°C.

CW-H-E1 applied for
FDC71VNX
FDC100~140VNX, VSX
FDC100~140VNA, VSA
FDC200/250VSA
FDC100VNP



Case study: Commercial

MHI aircon system recovers waste energy at Bristol Airport



A 375kW air conditioning installation from Mitsubishi Heavy Industries Thermal Systems has just checked in at Bristol Airport. Twenty multi-split systems from MHI's FD Micro Inverter range and 33 SAF fresh air heat exchange units service a hub of pre-boarding and arrivals areas plus a new two-storey walkway connection to the terminal building. MHI's FD Split and Multi Split Systems feature a cutting edge inverter controlled compressor that adjusts automatically to meet the precise demands of the indoor unit to save energy and reduce temperature fluctuations.

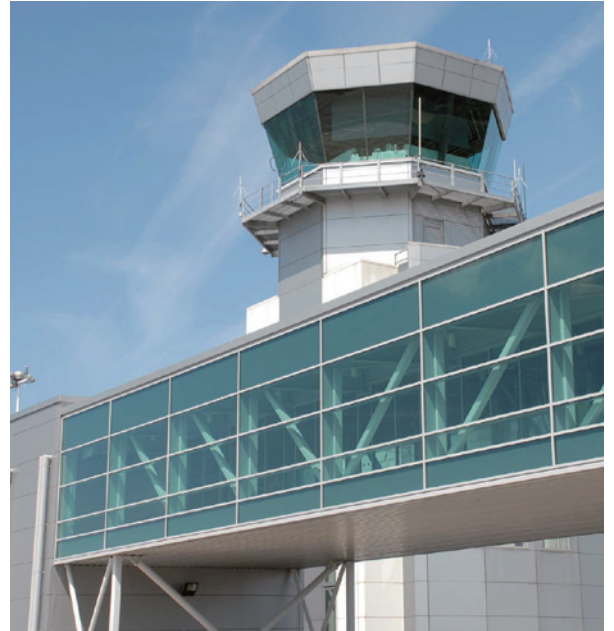

MHI aircon system offers bowling centres energy savings of up to 38%









High efficiency climate control from Mitsubishi Heavy Industries Thermal Systems has scored a strike at The Original Bowling Company, the UK's number one ten pin bowling operator. Outdated heating and cooling plant has been replaced with Mitsubishi Heavy Industries Thermal Systems heat pump systems at four Hollywood Bowl and AMF Bowling Centres so far, with further sites to follow in an ongoing refurbishment programme. The new systems employ MHI's inverter technology offering variable capacity control for consistent temperatures and energy savings of up to 38%.



PRODUCT LINE UP

SINGLE SPLITS

Type		Hyper Inverter						
		HP	1.5	2.0	2.5	3.0	4.0	
		kW	4.0	5.0	6.0	7.1	10.0	
		Btu/h	13,600	17,100	20,500	24,200	34,100	
		kcal/h	3,440	4,300	5,160	6,100	8,600	
CEILING CASSETTE	4way FDT 	P.26 Set	1Phase	FDT40ZSXVG	FDT50ZSXVG	FDT60ZSXVG	FDT71VNXVG	FDT100VNXVG
			3Phase					FDT100VSXVG
		Indoor unit	FDT40VG	FDT50VG	FDT60VG	FDT71VG	FDT100VG	
	Outdoor unit	1Phase	SRC40ZSX-S	SRC50ZSX-S	SRC60ZSX-S	FDC71VNX	FDC100VNX	
		3Phase					FDC100VSX	
	4way compact FDTC 	P.34 Set	1Phase	FDTC40ZSXVG	FDTC50ZSXVG	FDTC60ZSXVG		
Indoor unit			FDTC40VG	FDTC50VG	FDTC60VG			
Outdoor unit		1Phase	SRC40ZSX-S	SRC50ZSX-S	SRC60ZSX-S			
	3Phase							
DUCT CONNECTED	High Static pressure FDU 	P.38 Set	1Phase				FDU71VNXVF1	FDU100VNXVF2
			3Phase					FDU100VSXVF2
		Indoor unit				FDU71VF1	FDU100VF2	
	Outdoor unit	1Phase				FDC71VNX	FDC100VNX	
		3Phase					FDC100VSX	
	Low/Middle Static pressure FDUM 	P.43 Set	1Phase	FDUM40ZSXVF	FDUM50ZSXVF	FDUM60ZSXVF	FDUM71VNXVF1	FDUM100VNXVF2
3Phase							FDUM100VSXVF2	
Indoor unit		FDUM40VF	FDUM50VF	FDUM60VF	FDUM71VF1	FDUM100VF2		
Outdoor unit	1Phase	SRC40ZSX-S	SRC50ZSX-S	SRC60ZSX-S	FDC71VNX	FDC100VNX		
	3Phase					FDC100VSX		
WALL MOUNTED	SRK 	P.50 Set	1Phase					
			3Phase					
		Indoor unit						
Outdoor unit	1Phase							
	3Phase							
CEILING SUSPENDED	FDE 	P.54 Set	1Phase	FDE40ZSXVG	FDE50ZSXVG	FDE60ZSXVG	FDE71VNXVG	FDE100VNXVG
			3Phase					FDE100VSXVG
		Indoor unit	FDE40VG	FDE50VG	FDE60VG	FDE71VG	FDE100VG	
Outdoor unit	1Phase	SRC40ZSX-S	SRC50ZSX-S	SRC60ZSX-S	FDC71VNX	FDC100VNX		
	3Phase					FDC100VSX		
FLOOR STANDING	FDF 	P.62 Set	1Phase				FDF71VNXVD1	FDF100VNXVD2
			3Phase					FDF100VSXVD2
		Indoor unit				FDF71VD1	FDF100VD2	
		Outdoor unit	1Phase				FDC71VNX	FDC100VNX
3Phase						FDC100VSX		

Capacity Range (Nominal Cooling Capacity)

		<i>Micro Inverter</i>					<i>Standard Inverter</i>		
5.0	6.0	4.0	5.0	6.0	8.0	10.0	3.0	3.5	4.0
12.5	14.0	10.0	12.5	14.0	20.0	24.0	7.1	9.0	10.0
42,700	47,800	34,100	42,700	47,800	68,200	81,300	24,200	30,700	34,100
10,750	12,040	8,600	10,750	12,040	17,200	20,640	6,100	7,740	8,600
FDT125VNXVG	FDT140VNXVG	FDT100VNAV	FDT125VNAV	FDT140VNAV			FDT71VNPVG	FDT90VNP1VG	FDT100VNP1VG
FDT125VSXVG	FDT140VSXVG	FDT100VSAVG	FDT125VSAVG	FDT140VSAVG					
FDT125VG	FDT140VG	FDT100VG	FDT125VG	FDT140VG			FDT71VG	FDT100VG	FDT100VG
FDC125VNX	FDC140VNX	FDC100VNA	FDC125VNA	FDC140VNA			FDC71VNP	FDC90VNP1	FDC100VNP
FDC125VSX	FDC140VSX	FDC100VSA	FDC125VSA	FDC140VSA					
FDU125VNXVF	FDU140VNXVF	FDU100VNAV2	FDU125VNAV	FDU140VNAV			FDU71VNPVF1	FDU90VNP1VF2	FDU100VNP1VF2
FDU125VSXVF	FDU140VSXVF	FDU100VSAVF2	FDU125VSAVF	FDU140VSAVF	FDU200VSAVG	FDU250VSAVG			
FDU125VF	FDU140VF	FDU100VF2	FDU125VF	FDU140VF	FDU200VG	FDU250VG	FDU71VF1	FDU100VF2	FDU100VF2
FDC125VNX	FDC140VNX	FDC100VNA	FDC125VNA	FDC140VNA			FDC71VNP	FDC90VNP1	FDC100VNP
FDC125VSX	FDC140VSX	FDC100VSA	FDC125VSA	FDC140VSA	FDC200VSA	FDC250VSA			
FDUM125VNXVF	FDUM140VNXVF	FDUM100VNAV2	FDUM125VNAV	FDUM140VNAV			FDUM71VNPVF1	FDUM90VNP1VF2	FDUM100VNP1VF2
FDUM125VSXVF	FDUM140VSXVF	FDUM100VSAVF2	FDUM125VSAVF	FDUM140VSAVF					
FDUM125VF	FDUM140VF	FDUM100VF2	FDUM125VF	FDUM140VF			FDUM71VF1	FDUM100VF2	FDUM100VF2
FDC125VNX	FDC140VNX	FDC100VNA	FDC125VNA	FDC140VNA			FDC71VNP	FDC90VNP1	FDC100VNP
FDC125VSX	FDC140VSX	FDC100VSA	FDC125VSA	FDC140VSA					
		SRK100VNAZR							SRK100VNP1ZR
		SRK100VSAZR							
		SRK100ZR-S							SRK100ZR-S
		FDC100VNA							FDC100VNP
		FDC100VSA							
FDE125VNXVG	FDE140VNXVG	FDE100VNAV	FDE125VNAV	FDE140VNAV			FDE71VNPVG	FDE90VNP1VG	FDE100VNP1VG
FDE125VSXVG	FDE140VSXVG	FDE100VSAVG	FDE125VSAVG	FDE140VSAVG					
FDE125VG	FDE140VG	FDE100VG	FDE125VG	FDE140VG			FDE71VG	FDE100VG	FDE100VG
FDC125VNX	FDC140VNX	FDC100VNA	FDC125VNA	FDC140VNA			FDC71VNP	FDC90VNP1	FDC100VNP
FDC125VSX	FDC140VSX	FDC100VSA	FDC125VSA	FDC140VSA					
PDF125VNXVD	PDF140VNXVD	PDF100VNAV2	PDF125VNAV	PDF140VNAV			PDF71VNPVD1	PDF90VNP1VD2	PDF100VNP1VD2
PDF125VSXVD	PDF140VSXVD	PDF100VSAVD2	PDF125VSAVD	PDF140VSAVD					
PDF125VD	PDF140VD	PDF100VD2	PDF125VD	PDF140VD			PDF71VD1	PDF100VD2	PDF100VD2
FDC125VNX	FDC140VNX	FDC100VNA	FDC125VNA	FDC140VNA			FDC71VNP	FDC90VNP1	FDC100VNP
FDC125VSX	FDC140VSX	FDC100VSA	FDC125VSA	FDC140VSA					

PRODUCT LINE UP







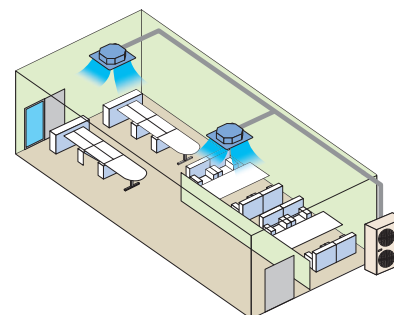

MULTI SYSTEM

Twin / Triple / Double Twin Multi System

Up to Four indoor units can be connected to a single outdoor unit and simultaneously operated with a single remote control. By referring to the following table for applicable indoor units, select the same models and capacities.



Combination of indoor units







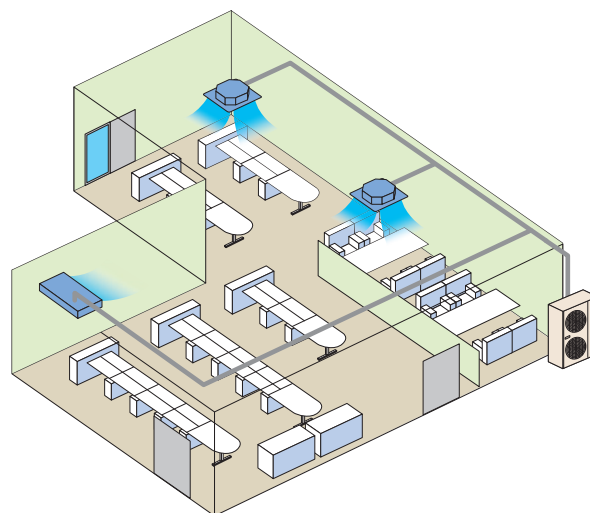

Outdoor Unit	Hyper Inverter				Micro Inverter				
									
	FDC71VNX	FDC100VNX FDC100VSX	FDC125VNX FDC125VSX	FDC140VNX FDC140VSX	FDC100VNA FDC100VSA	FDC125VNA FDC125VSA	FDC140VNA FDC140VSA	FDC200VSA	FDC250VSA
Twin	40 + 40	50 + 50	60 + 60	71 + 71	50 + 50	60 + 60	71 + 71	100 + 100	125 + 125
Triple				50 + 50 + 50			50 + 50 + 50	71 + 71 + 71	
Double Twin								50+50+50+50	60+60+60+60

V Multi System

Ideal for the installation in large area and L-shaped rooms, the V Multi System has an extensive degree of flexibility in the selection of indoor units. Specifically, the selection of indoor units with different capacities in different types can be made.



Combination of indoor units

Outdoor Unit	Hyper Inverter				Micro Inverter				
									
	FDC71VNX	FDC100VNX FDC100VSX	FDC125VNX FDC125VSX	FDC140VNX FDC140VSX	FDC100VNA FDC100VSA	FDC125VNA FDC125VSA	FDC140VNA FDC140VSA	FDC200VSA	FDC250VSA
Twin	40 + 40	50 + 50	60 + 60 50 + 71	71 + 71	50 + 50	60 + 60 50 + 71	71 + 71	100 + 100 71 + 125	125 + 125
Triple				50 + 50 + 50			50 + 50 + 50	71 + 71 + 71	60+60+125 71+71+100
Double Twin								50+50+50+50	60+60+60+60

Applicable indoor units

Model		Capacity					
		40	50	60	71	100	125
Twin Triple Double Twin Multi System	4way FDT	●	●	●	●	●	●
	4way compact FDTc	●	●	●			
	Low/Middle Static pressure FDUM	●	●	●	●	●	●
	Wall Mounted SRK		● *	● *		●	
	Ceiling Suspended FDE	●	●	●	●	●	●
	Floor Standing FDF				●	●	●
V Multi System	4way FDT	●	●	●	●	●	●
	Ceiling Suspended FDE	●	●	●	●	●	●

* Hyper inverter combination only

Decision of piping specification

Diagrams below show the application as samples. For further information, refer to TECHNICAL MANUAL.

Twin type

Models **FDC71, FDC100~140, FDC200, FDC250**
 [Branch pipe set : DIS-WA1G, DIS-WB1G]

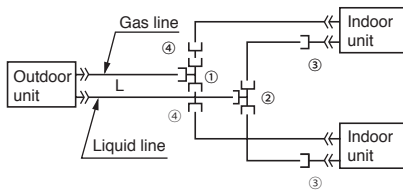

Triple type

Model **FDC140, FDC200**
 [Branch pipe set : DIS-TA1G, DIS-TB1G]

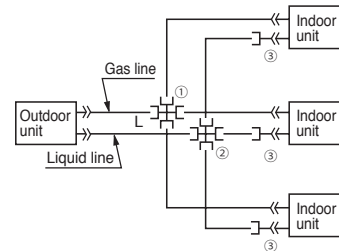

The indoor_outdoor piping length differences among indoor units are less than 3m.

Chart of shapes of branch piping parts

- Symbol ① to ④ in the drawing shows the symbols of branch piping parts in the chart respectively.
- Branch piping should always be arranged to have level or perpendicular position.

Branching pipe set type	Outdoor unit	Indoor unit combinations	Symbol		
			Branching pipe set for a gas pipe	Branching pipe set for a liquid pipe	Different diameter pipe joint
DIS-WA1G (Two-way branching set)	FDC71	40+40	① ID15.88	② ID9.52	③ Joint A ID9.52 2 pieces Flare Joint (for indoor unit side connection)
	FDC100	50+50	① ID15.88 1 piece ID15.88	② ID9.52 1 piece ID9.52	④ Joint B 2 pieces OD15.88 ID12.7
	FDC125	60+60 50+71			
	FDC140	71+71			
DIS-WB1G (Two-way branching set)	FDC200	100+100	① ID15.88	② ID9.52	④ Joint C 1 piece OD12.7 ID9.52
		71+125	① ID25.4 1 piece ID15.88	② ID12.7 1 piece ID9.52	
	FDC250	125+125			
DIS-TA1G (Three-way branching set)	FDC140	50+50+50			① ID12.7 1 piece ID15.88
DIS-TB1G (Three-way branching set)	FDC200	71+71+71	① ID15.88 1 piece ID25.4	② ID9.52 1 piece ID9.52	③ Joint A ID9.52 2 pieces Flare joint(for indoor unit side connection) Joint B 1 piece OD15.88 ID12.7 Joint D 1 piece ID12.7 OD9.52

Notes

- (1) When 40-60 models of indoor units are applied to this combination, the reducer ③ supplied with the branch piping set should be used in order to reduce the liquid piping size from $\varnothing 9.52\text{mm}$ to $\varnothing 6.35\text{mm}$ at indoor unit side (flare connection). Accordingly be sure to select the liquid piping size $\varnothing 9.52\text{mm}$ from branch to indoor unit.
- (2) The reducer ④ is for FDC71 and 100 models only.

ID stands for inner diameter and OD, outer diameter.

The branch piping (both gas and liquid lines) should always be arranged to have a level or perpendicular position.

2-Way Branch

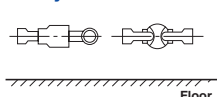

Mount — sections level with the floor.

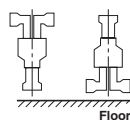

Mount — sections perpendicular to the floor.

3-Way Branch

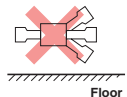
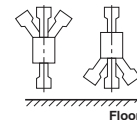
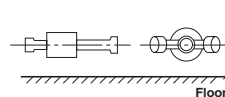

BENEFITS SUMMARY

Indoor units

When using RC-EX3A (Remote control), functions with symbol  are available. However, for RC-E5 (Remote control), functions with * are not available.

Economy	Inverter technology 	Inverter control technology functions at high efficiency with smooth operation from high speed to low speed. A smooth sine voltage wave is attained.
	Energy-saving *	 Since the capacity is controlled automatically based on the outdoor temperature, energy can be saved without losing comfort.
	Home Leave Operation 	This function ensures that when the room is unoccupied for long periods of time, the unit will maintain a moderate indoor temperature, avoiding extremely hot or cool temperatures.
	Set Temperature Auto Return *	 This function allows you to program a preferred set temperature that the unit will return to each time it is operated.
Comfort	Automatic Operation 	This function automatically selects the required heating or cooling function based on the current room conditions.
	Silent Operation 	This function allows you to program periods where the unit will operate with reduced noise levels, perfect for night time and an uninterrupted sleep.
	Motion sensor *	 This sensor detects human activity and shifts the temperature setting according to the amount of activity in the room.
	Hi Power Operation 	Use the high power function to quickly reach your optimum temperature level when you first turn on the unit. This function will operate for a maximum of 15 minutes before returning to normal operation.
Air flow	Flap Control System 	This function allows you to set the upper and lower limit positions of the flap at each air outlet individually, providing you with complete control over interior air flow.
	Vertical Auto Swing 	The vertical louvers on your unit will move up and down continuously during operation. This function allows you to set the up/down swing position of the louver to your preferred operation angle.
	Draft prevention setting *	 Draft Prevention setting provides a comfortable air flow without any draft feeling. Whether cooling or heating a room, the remote control can be used to instantly suppress any warm or cool drafts. This accurately assists how air flow is directed out of the indoor unit.
	Automatic Fan Speed 	The unit's on-board microcomputer continuously monitors the room's air temperature and adjusts the air flow automatically.
Timer	Sleep Timer 	This function allows you to set a pre-determined amount of time between 30 and 240 minutes that your unit will operate for before switching off.
	Peak-Cut Timer *	 This function lets you to preset the capacity limit during certain periods of the day, minimising energy consumption during peak billing times, thus reducing operation costs.
	Weekly Timer 	Set your unit to turn on and off automatically on a weekly basis to suit your usual room usage on each day.
Convenient	Function Switch *	 From the seven available functions on the unit, this function allows you to set two functions to operate automatically.
	Favorite setting *	 Operation mode, set temperature, fan speed and air flow direction automatically adjust to the programmed favorite setting.
	Select the language *	 Set the language to be displayed on the remote control.
	Air Filter 	The air filter in the unit traps and removes airborne dust particles and other allergens to provide you with a clean air function.
	Filter Sign 	This warning alerts you to when the filter needs to be cleaned.
	Outside Air Intake 	This function provides clean fresh air into the room through the external air intake, avoiding the constant recycling of internal air.
Others	Self Diagnostics 	The internal microcomputer automatically runs a diagnostic of the system in the event of a malfunction. This enables your authorised dealer to isolate and repair any issues.
	Built in Drain Pump 	The built-in drain pump, allows greater flexibility with installation, offering a great solution for applications with limited space.
	Improved Serviceability 	The fan unit (comprised of impeller and motor) is easily accessible from either the side or bottom of the unit and can be slid out for easy maintenance.

FDT	FDTC	FDU	FDUM	SRK	FDE	FDf
●	●	●	●	●	●	●
●	●	●	●	●	●	
●	●	●	●	●	●	
●	●	●	●	●	●	
●	●	●	●	●	●	●
●	●	●	●	●	●	●
● Option	● Option					
●	●	●	●	●	●	
●	●			●	●	
●	●			●	●	●
● Option	● Option					
●	●	●	●	●	●	
●	●	●	●	●	●	
●	●	●	●	●	●	●
●	●	●	●	●	●	
●	●	●	●	●	●	
●	●	●	●	●	●	
●	●	●	●	●	●	
●	●	●	●	●	●	
●	●	●	●	●	●	●
●	●	●	●	●	●	●
●	●	●	●	●	●	
●	● Option	●	●		●	
●	●	●	●	●	●	●
●	●	●	●		●	
●	●	●	●	●	●	
●	●	● *1	●			
		●	●			

*1 : Except 200 • 250

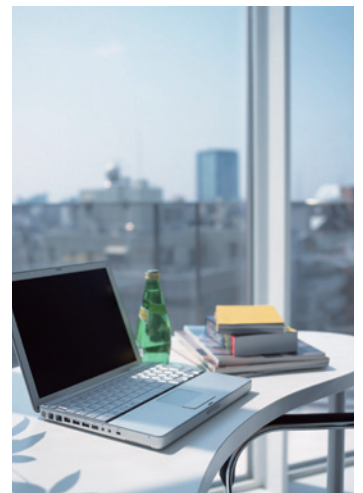
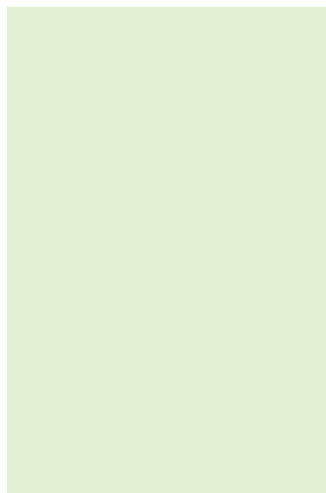
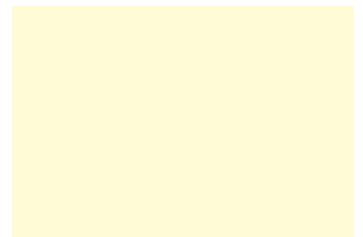

CEILING CASSETTE -4way- FDT



FDT 40/50/60/71/100/125/140

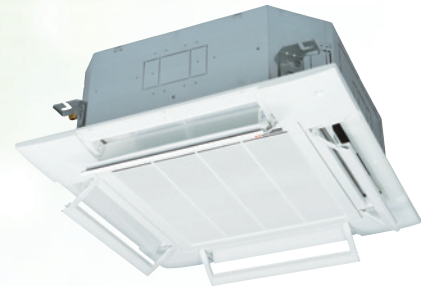

Draft Prevention Panel (Option)



*Not all functions available with all remote control options.

Point 1 Draft Prevention Panel (Option)

Draft Prevention Panel prevents cold/hot draft being blown directly on the user. It is possible to set Draft Prevention Panel for each air outlet.

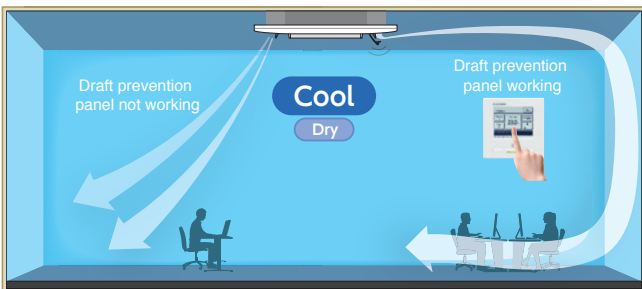

User can position Draft Prevention Panel panels by using the remote controller only (RC-EX3A, RCN-T-5AW-E2).

Point 2 Motion Sensor (Option)

Motion sensor is equipped in the panel corner and detects the presence/absence and activity of humans in a room to improve the comfort and energy saving performance of the unit.

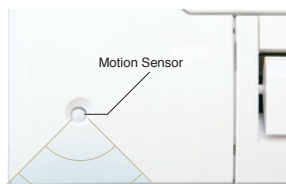

LB-T-5W-E



Point 3 Individual flap control system

According to room conditions, four directions of air flow can be controlled individually by utilizing the flap control system. Individual flap control is available even after installation.

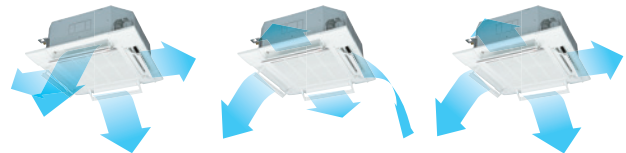

Flap can swing within an upper and lower flap range position within a can be selected with a wired remote control.

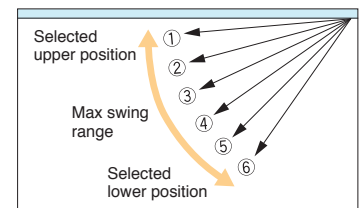

*The wireless remote control is not applicable to the Individual flap control system.

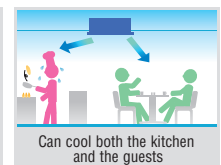
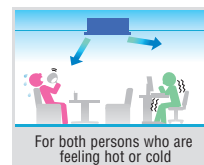
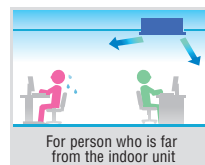

Point 4 More quiet noise

New technology has realised quiet noise with keeping capacity and comfort.

(Comparison of current model)

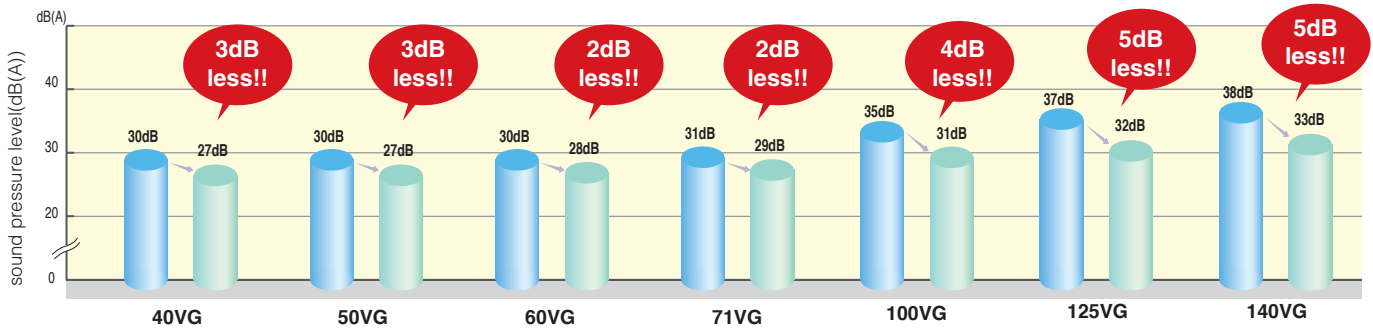

Point 5 Panel select pattern (Option)

8 patterns of panel are available.

Installation position of Wireless kit and Motion sensor kit

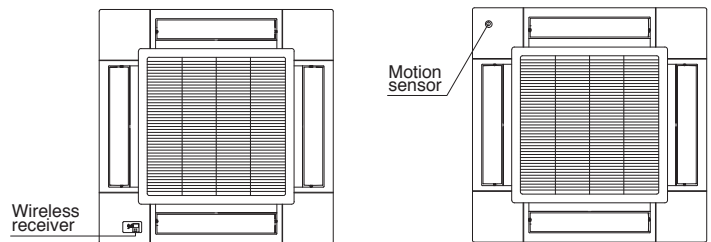
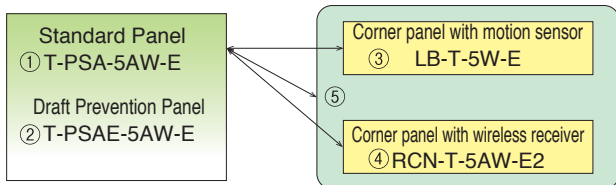

*Wireless receiver and Motion sensor can be installed to the position as shown

- ① Standard Panel only
- ①+③ Standard Panel with corner panel with motion sensor
- ①+④ Standard Panel with corner panel with wireless receiver
- ①+⑤ Standard Panel with corner panel with motion sensor & corner panel with wireless receiver
- ② Draft Prevention Panel only
- ②+③ Draft Prevention Panel with corner panel with motion sensor
- ②+④ Draft Prevention Panel with corner panel with wireless receiver
- ②+⑤ Draft Prevention Panel with corner panel with motion sensor & corner panel with wireless receiver

Point 6 850mm Drain Pump

Drain can be discharged upwards by 850mm from the ceiling surface. It allows a piping layout with a high degree of freedom. Depending on the installation location and 185mm flexible hose as a standard equipment supports easy workability.

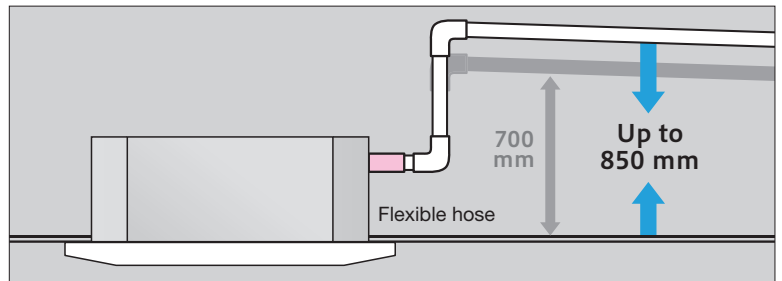

OUTDOOR UNIT

SRC · FDC	Hyper Inverter			Micro Inverter		
	40~60ZSX	71VNX	100~140VN(S)X	100~140VN(S)A	200VSA	250VSA
model						
Chargeless	15m	30m		30m		
Height x Width x Depth (mm)	640 x 800(+71) x 290	750 x 880(+88) x 340	1,300 x 970 x 370	845 x 970 x 370	1,300 x 970 x 370	1,505 x 970 x 370

FDC	Standard Inverter		
	71VNP	90VNP1	100VNP
model			
Chargeless	15m		
Height x Width x Depth (mm)	640 x 800(+71) x 290	750 x 880(+88) x 340	845 x 970 x 370

DIMENSIONS (Unit:mm)

Models FDT40VG,50VG,60VG,71VG

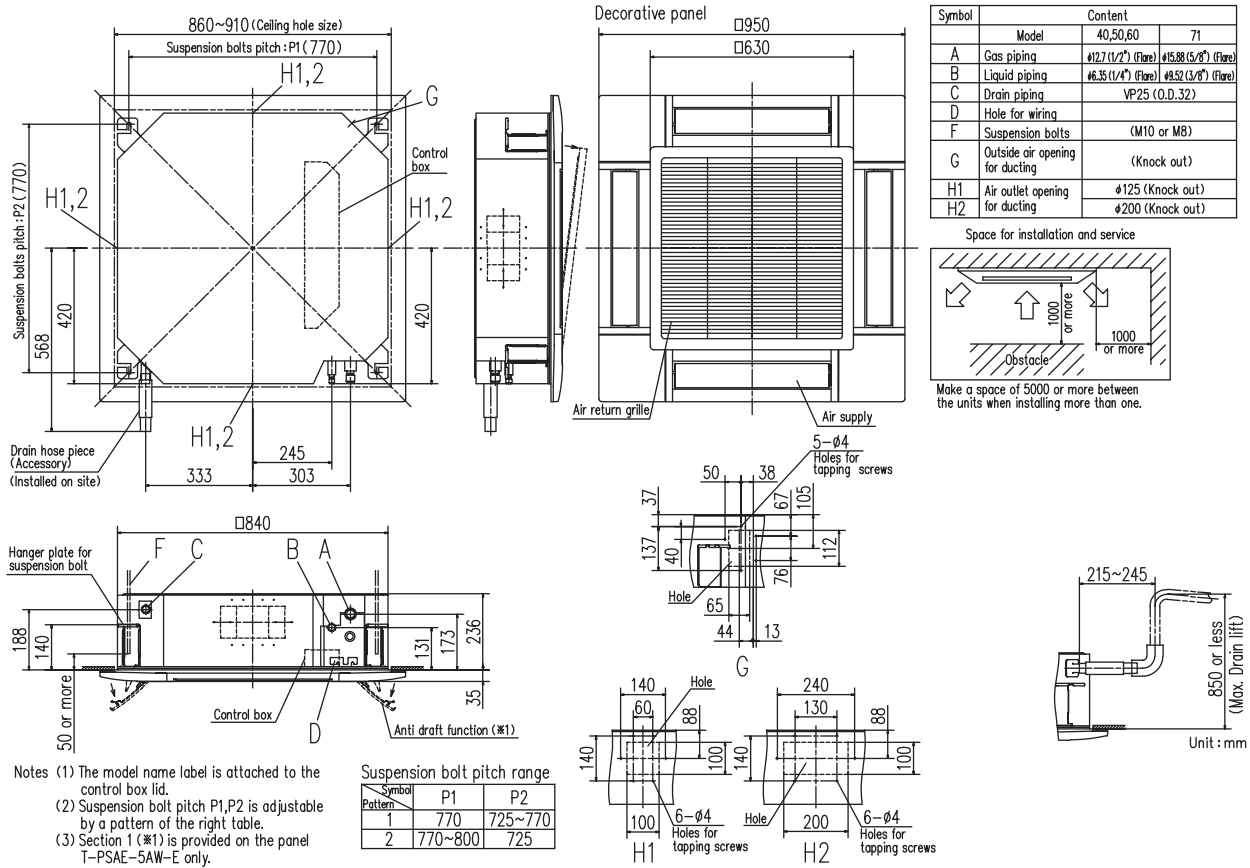

Models FDT100VG,125VG,140VG

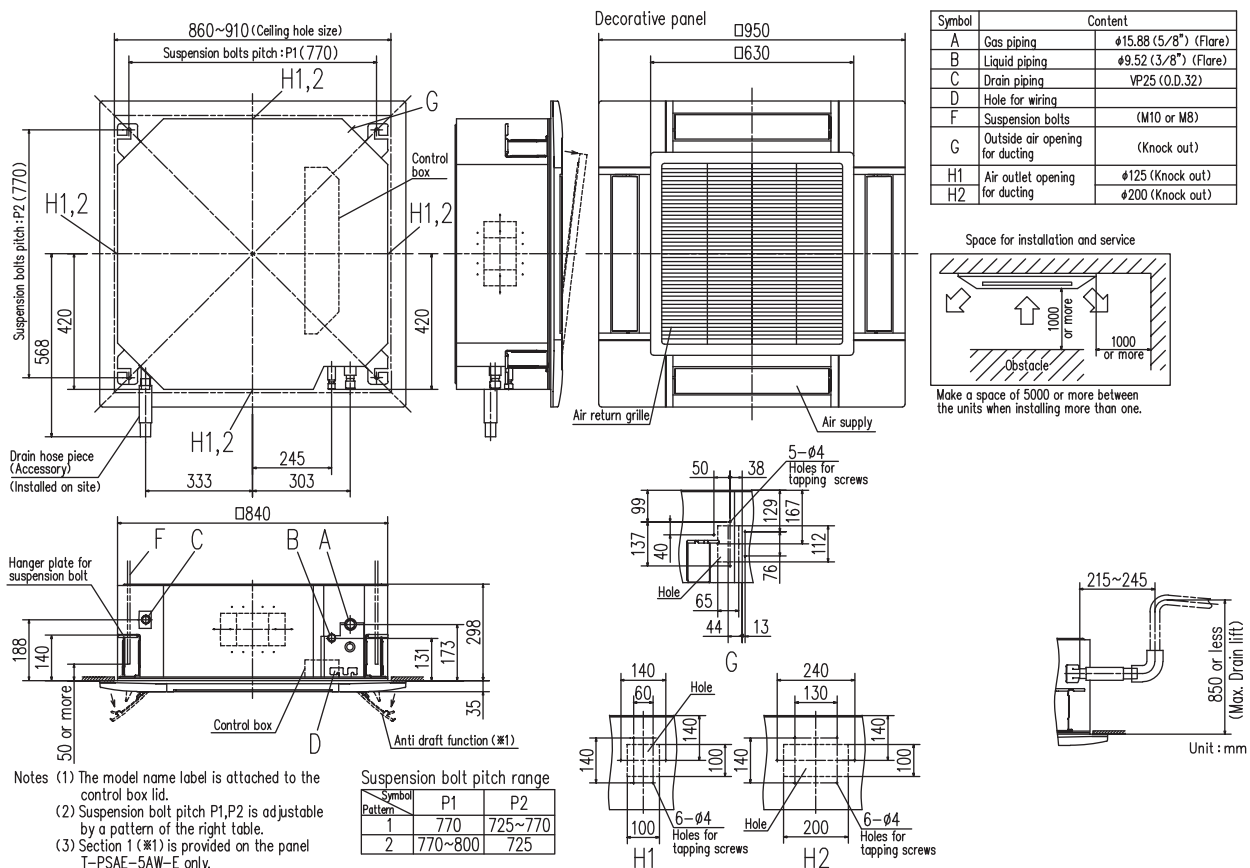

SPECIFICATIONS

		<i>HyperInverter</i>			
Set model name		FDT40ZSXVG	FDT50ZSXVG	FDT60ZSXVG	FDT71VNXVG
Indoor unit		FDT40VG	FDT50VG	FDT60VG	FDT71VG
Outdoor unit		SRC40ZSX-S	SRC50ZSX-S	SRC60ZSX-S	FDC71VNX
Power source		1 Phase 220-240V, 50Hz / 220V, 60Hz			
Nominal cooling capacity (Min~Max)		kW 4.0 (1.1 ~ 4.7)	5.0 (1.1 ~ 5.6)	5.6 (1.1 ~ 6.3)	7.1 (3.2 ~ 8.0)
Nominal heating capacity (Min~Max)		kW 4.5 (0.6 ~ 5.4)	5.4 (0.6 ~ 6.3)	6.7 (0.6 ~ 7.1)	8.0 (3.6 ~ 9.0)
Power consumption	Cooling/Heating	kW 0.93 / 1.03	1.29 / 1.29	1.52 / 1.56	1.94 / 1.91
	EER/COP	Cooling/Heating 4.30 / 4.37	3.88 / 4.19	3.68 / 4.29	3.66 / 4.19
Inrush current		A	5	5	5
Max. current			12	15	15
Sound power level*1	Indoor	Cooling/Heating	53 / 53	54 / 54	60 / 60
	Outdoor		Cooling/Heating	63 / 63	63 / 63
Sound pressure level*1	Indoor	Cooling (P-Hi/Hi/Me/Lo)	36 / 33 / 30 / 27	38 / 33 / 30 / 27	44 / 34 / 32 / 28
		Heating (P-Hi/Hi/Me/Lo)	36 / 33 / 30 / 27	38 / 33 / 30 / 27	44 / 34 / 32 / 28
	Outdoor	Cooling/Heating	50 / 49	50 / 49	52 / 52
		Cooling/Heating	19 / 16 / 13 / 10	20 / 16 / 13 / 10	26 / 17 / 14 / 11
Air flow	Indoor	Cooling (P-Hi/Hi/Me/Lo)	19 / 16 / 13 / 10	20 / 16 / 13 / 10	26 / 17 / 14 / 11
	Outdoor	Cooling/Heating	36 / 33	39 / 33	41.5 / 39
Exterior dimensions		Indoor	Unit: 236 x 840 x 840 Panel: 35 x 950 x 950		
		Outdoor	640 x 800(+71) x 290		
			750 x 880(+88) x 340		
Net weight		Indoor	24(Unit:19 Standard Panel:5)		26(Unit:21 Standard Panel:5)
		Outdoor	45		60
Ref.piping size	Liquid/Gas	ømm	6.35(1/4") / 12.7(1/2")		9.52(3/8") / 15.88(5/8")
Refrigerant line (one way) length		m	Max.30		Max. 50
Vertical height differences		Outdoor is higher/lower	Max.20 / Max.20		Max.30 / Max.15
Outdoor operating temperature range	Cooling	°C	-15~46*2		-15~43*3
	Heating		-20~24		-20~20
Panel		T-PSA-5AW-E, T-PSAE-5AW-E			
Air filter, Q'ty		Pocket plastic net x 1(Washable)			
Remote control (option)		wired:RC-EX3A, RC-E5, RCH-E3 wireless:RCN-T-5AW-E2			

		<i>HyperInverter</i>					
Set model name		FDT100VNXVG	FDT125VNXVG	FDT140VNXVG	FDT100VSXVG	FDT125VSXVG	FDT140VSXVG
Indoor unit		FDT100VG	FDT125VG	FDT140VG	FDT100VG	FDT125VG	FDT140VG
Outdoor unit		FDC100VNX	FDC125VNX	FDC140VNX	FDC100VSX	FDC125VSX	FDC140VSX
Power source		1 Phase 220-240V, 50Hz / 220V, 60Hz			3 Phase 380-415V, 50Hz / 380V, 60Hz		
Nominal cooling capacity (Min~Max)		kW 10.0 (4.0 ~ 11.2)	12.5 (5.0 ~ 14.0)	14.0 (5.0 ~ 16.0)	10.0 (4.0 ~ 11.2)	12.5 (5.0 ~ 14.0)	14.0 (5.0 ~ 16.0)
Nominal heating capacity (Min~Max)		kW 11.2 (4.0 ~ 12.5)	14.0 (4.0 ~ 17.0)	16.0 (4.0 ~ 18.0)	11.2 (4.0 ~ 16.0)	14.0 (4.0 ~ 18.0)	16.0 (4.0 ~ 20.0)
Power consumption	Cooling/Heating	kW 2.50 / 2.58	3.42 / 3.43	4.26 / 4.20	2.50 / 2.58	3.42 / 3.43	4.26 / 4.20
	EER/COP	Cooling/Heating 4.00 / 4.34	3.65 / 4.08	3.29 / 3.81	4.00 / 4.34	3.65 / 4.08	3.29 / 3.81
Inrush current		A	5	5	5	5	5
Max. current			24	26	26	15	15
Sound power level*1	Indoor	Cooling/Heating	63 / 63	64 / 64	64 / 64	63 / 63	64 / 64
	Outdoor		Cooling/Heating	70 / 70	70 / 70	72 / 72	70 / 70
Sound pressure level*1	Indoor	Cooling (P-Hi/Hi/Me/Lo)	48 / 39 / 37 / 31	49 / 41 / 39 / 32	49 / 42 / 39 / 33	48 / 39 / 37 / 31	49 / 41 / 39 / 32
		Heating (P-Hi/Hi/Me/Lo)	48 / 39 / 37 / 31	49 / 41 / 39 / 32	49 / 42 / 39 / 33	48 / 39 / 37 / 31	49 / 41 / 39 / 32
	Outdoor	Cooling/Heating	48 / 50	48 / 50	49 / 52	48 / 50	48 / 50
		Cooling/Heating	37 / 26 / 23 / 17	38 / 28 / 25 / 18	38 / 29 / 26 / 19	39 / 26 / 23 / 17	38 / 28 / 25 / 18
Air flow	Indoor	Cooling (P-Hi/Hi/Me/Lo)	37 / 26 / 23 / 17	38 / 28 / 25 / 18	38 / 29 / 26 / 19	39 / 26 / 23 / 17	38 / 28 / 25 / 18
	Outdoor	Cooling/Heating	100 / 100	100 / 100	100 / 100	100 / 100	100 / 100
Exterior dimensions		Indoor	Unit: 298 x 840 x 840 Panel: 35 x 950 x 950				
		Outdoor	1,300 x 970 x 370				
Net weight		Indoor	30(Unit:25 Standard Panel:5)				
		Outdoor	105				
Ref.piping size	Liquid/Gas	ømm	9.52(3/8") / 15.88(5/8")				
Refrigerant line (one way) length		m	Max.100				
Vertical height differences		Outdoor is higher/lower	Max.30 / Max.15				
Outdoor operating temperature range	Cooling	°C	-15~43*2				
	Heating		-20~20				
Panel		T-PSA-5AW-E, T-PSAE-5AW-E					
Air filter, Q'ty		Pocket plastic net x 1(Washable)					
Remote control (option)		wired:RC-EX3A, RC-E5, RCH-E3 wireless:RCN-T-5AW-E2					

NOTES:

The data are measured under the following conditions(ISO-T1).

Cooling:Indoor temp. of 27°CDB, 19°CWB, and outdoor temp. of 35°CDB. Heating:Indoor temp. of 20°CDB, and outdoor temp. of 7°CDB, 6°CWB.

*1 : Indicates the value in an anechoic chamber. During operation these values are somewhat higher due to ambient conditions.

*2 : If a cooling operation is conducted when the outdoor air temperature is -5°C or lower, the outdoor unit should be installed at a place where it is not influenced by natural wind. If wind blows, the low pressure will drop and compressor frequency will increase, this will cause the capacity to drop and may cause the unit to break down.

SPECIFICATIONS

The values are for simultaneous Multi operation.

Set model name		Hyper Inverter				
		FDT71VNXPGV	FDT100VNXPGV	FDT125VNXPGV	FDT140VNXPGV	FDT140VNXTVG
		Twin				Triple
Indoor unit		FDT40VG x 2	FDT50VG x 2	FDT60VG x 2	FDT71VG x 2	FDT50VG x 3
Outdoor unit		FDC71VNX	FDC100VNX	FDC125VNX	FDC140VNX	FDC140VNX
Power source		1 Phase 220-240V, 50Hz / 220V, 60Hz				
Nominal cooling capacity (Min~Max)	kW	7.1 (3.2 ~ 8.0)	10.0 (4.0 ~ 11.2)	12.5 (5.0 ~ 14.0)	14.0 (5.0 ~ 16.0)	14.0 (5.0 ~ 16.0)
Nominal heating capacity (Min~Max)	kW	8.0 (3.6 ~ 9.0)	11.2 (4.0 ~ 12.5)	14.0 (4.0 ~ 17.0)	16.0 (4.0 ~ 18.0)	16.0 (4.0 ~ 18.0)
Power consumption	Cooling/Heating	1.85 / 1.99	2.56 / 2.67	3.26 / 3.22	3.88 / 3.74	3.93 / 4.00
EER/COP	Cooling/Heating	3.84 / 4.02	3.91 / 4.19	3.83 / 4.35	3.61 / 4.28	3.56 / 4.00
Inrush current		5	5	5	5	5
Max. current		17	24	26	26	26
Sound power level*1	Indoor*2	Cooling/Heating	53 / 53	54 / 54	60 / 60	62 / 62
	Outdoor	Cooling/Heating	66 / 66	70 / 70	70 / 70	72 / 72
Sound pressure level*1	Indoor*2	Cooling (P-Hi/Hi/Me/Lo)	36 / 33 / 30 / 27	38 / 33 / 30 / 27	44 / 34 / 32 / 28	46 / 35 / 34 / 29
		Heating (P-Hi/Hi/Me/Lo)	36 / 33 / 30 / 27	38 / 33 / 30 / 27	44 / 34 / 32 / 28	46 / 35 / 34 / 29
	Outdoor	Cooling/Heating	51 / 48	48 / 50	48 / 50	49 / 52
		Cooling/Heating	19 / 16 / 13 / 10	20 / 16 / 13 / 10	26 / 17 / 14 / 11	28 / 18 / 15 / 12
Air flow	Indoor*2	Cooling (P-Hi/Hi/Me/Lo)	19 / 16 / 13 / 10	20 / 16 / 13 / 10	26 / 17 / 14 / 11	28 / 18 / 15 / 12
	Outdoor	Cooling/Heating	60 / 50	100 / 100	100 / 100	100 / 100
Exterior dimensions	Indoor	HeightxWidthxDpeth	Unit: 236 x 840 x 840 Panel: 35 x 950 x 950			
	Outdoor	HeightxWidthxDpeth	750 x 880(+88) x 340	1,300 x 970 x 370		
Net weight	Indoor		24(Unit:19 Standard Panel:5)		26(Unit:21 Standard Panel:5)	
	Outdoor		60	105		
Ref.piping size	Liquid/Gas		9.52(3/8") / 15.88(5/8")			
Refrigerant line (one way) length		m	Max. 50	Max. 100		
Vertical height differences	Outdoor is higher/lower	m	Max.30 / Max.15			
Outdoor operating temperature range	Cooling	°C	-15~43*3			
	Heating	°C	-20~20			
Panel			T-PSA-5AW-E, T-PSAE-5AW-E			
Air filter, Q'ty			Pocket plastic net x 1(Washable)			
Remote control (option)			wired:RC-EX3A, RC-E5, RCH-E3 wireless:RCN-T-5AW-E2			

The values are for simultaneous Multi operation.

Set model name		Hyper Inverter			
		FDT100VSXPVG	FDT125VSXPVG	FDT140VSXPVG	FDT140VSXTVG
		Twin			Triple
Indoor unit		FDT50VG x 2	FDT60VG x 2	FDT71VG x 2	FDT50VG x 3
Outdoor unit		FDC100VSX	FDC125VSX	FDC140VSX	FDC140VSX
Power source		3 Phase 380-415V, 50Hz / 380V, 60Hz			
Nominal cooling capacity (Min~Max)	kW	10.0 (4.0 ~ 11.2)	12.5 (5.0 ~ 14.0)	14.0 (5.0 ~ 16.0)	14.0 (5.0 ~ 16.0)
Nominal heating capacity (Min~Max)	kW	11.2 (4.0 ~ 16.0)	14.0 (4.0 ~ 18.0)	16.0 (4.0 ~ 20.0)	16.0 (4.0 ~ 20.0)
Power consumption	Cooling/Heating	2.56 / 2.67	3.26 / 3.22	3.88 / 3.74	3.93 / 4.00
EER/COP	Cooling/Heating	3.91 / 4.19	3.83 / 4.35	3.61 / 4.28	3.56 / 4.00
Inrush current		5	5	5	5
Max. current		15	15	15	15
Sound power level*1	Indoor*2	Cooling/Heating	54 / 54	60 / 60	62 / 62
	Outdoor	Cooling/Heating	70 / 70	70 / 70	72 / 72
Sound pressure level*1	Indoor*2	Cooling (P-Hi/Hi/Me/Lo)	38 / 33 / 30 / 27	44 / 34 / 32 / 28	46 / 35 / 34 / 29
		Heating (P-Hi/Hi/Me/Lo)	38 / 33 / 30 / 27	44 / 34 / 32 / 28	46 / 35 / 34 / 29
	Outdoor	Cooling/Heating	48 / 50	48 / 50	49 / 52
		Cooling/Heating	20 / 16 / 13 / 10	26 / 17 / 14 / 11	28 / 18 / 15 / 12
Air flow	Indoor*2	Cooling (P-Hi/Hi/Me/Lo)	20 / 16 / 13 / 10	26 / 17 / 14 / 11	28 / 18 / 15 / 12
	Outdoor	Cooling/Heating	100 / 100	100 / 100	100 / 100
Exterior dimensions	Indoor	HeightxWidthxDpeth	Unit: 236 x 840 x 840 Panel: 35 x 950 x 950		
	Outdoor	HeightxWidthxDpeth	1,300 x 970 x 370		
Net weight	Indoor		24(Unit:19 Standard Panel:5)		26(Unit:21 Standard Panel:5)
	Outdoor		105		
Ref.piping size	Liquid/Gas		9.52(3/8") / 15.88(5/8")		
Refrigerant line (one way) length		m	Max.100		
Vertical height differences	Outdoor is higher/lower	m	Max.30 / Max.15		
Outdoor operating temperature range	Cooling	°C	-15~43*3		
	Heating	°C	-20~20		
Panel			T-PSA-5AW-E, T-PSAE-5AW-E		
Air filter, Q'ty			Pocket plastic net x 1(Washable)		
Remote control (option)			wired:RC-EX3A, RC-E5, RCH-E3 wireless:RCN-T-5AW-E2		

NOTES:

The data are measured under the following conditions(ISO-T1).
Cooling:Indoor temp. of 27°CDB, 19°CWB, and outdoor temp. of 35°CDB. Heating:Indoor temp. of 20°CDB, and outdoor temp. of 7°CDB, 6°CWB.
*1 : Indicates the value in an anechoic chamber. During operation these values are somewhat higher due to ambient conditions.
*2 : The values are for one indoor unit operation. (Multi system only)
*3 : If a cooling operation is conducted when the outdoor air temperature is -5°C or lower, the outdoor unit should be installed at a place where it is not influenced by natural wind. If wind blows, the low pressure will drop and compressor frequency will increase, this will cause the capacity to drop and may cause the unit to break down.

SPECIFICATIONS

		Micro Inverter					
Set model name		FDT100VNAVG	FDT125VNAVG	FDT140VNAVG	FDT100VSAVG	FDT125VSAVG	FDT140VSAVG
Indoor unit		FDT100VG	FDT125VG	FDT140VG	FDT100VG	FDT125VG	FDT140VG
Outdoor unit		FDC100VNA	FDC125VNA	FDC140VNA	FDC100VSA	FDC125VSA	FDC140VSA
Power source		1 Phase 220-240V, 50Hz / 220V, 60Hz			3 Phase 380-415V, 50Hz / 380V, 60Hz		
Nominal cooling capacity (Min~Max)		kW 10.0 (4.0 ~ 11.2)	12.5 (5.0 ~ 14.0)	13.6 (5.0 ~ 14.5)	10.0 (4.0 ~ 11.2)	12.5 (5.0 ~ 14.0)	13.6 (5.0 ~ 14.5)
Nominal heating capacity (Min~Max)		kW 11.2 (4.0 ~ 12.5)	14.0 (4.0 ~ 16.0)	15.5 (4.0 ~ 16.5)	11.2 (4.0 ~ 12.5)	14.0 (4.0 ~ 16.0)	15.5 (4.0 ~ 16.5)
Power consumption	Cooling/Heating	kW 2.73 / 2.64	4.05 / 3.74	4.84 / 4.43	2.73 / 2.63	4.05 / 3.74	4.84 / 4.43
EER/COP	Cooling/Heating	3.66 / 4.26	3.09 / 3.74	2.81 / 3.50	3.66 / 4.26	3.09 / 3.74	2.81 / 3.50
Inrush current		A 5	5	5	5	5	5
Max. current		24	24	24	15	15	15
Sound power level*1	Indoor	Cooling/Heating	63 / 63	64 / 64	64 / 64	63 / 63	64 / 64
	Outdoor	Cooling/Heating	70 / 70	71 / 71	73 / 73	70 / 70	71 / 71
Sound pressure level*1	Indoor	Cooling (P-Hi/Hi/Me/Lo)	48 / 39 / 37 / 31	49 / 41 / 39 / 32	49 / 42 / 39 / 33	48 / 39 / 37 / 31	49 / 41 / 39 / 32
		Heating (P-Hi/Hi/Me/Lo)	48 / 39 / 37 / 31	49 / 41 / 39 / 32	49 / 42 / 39 / 33	48 / 39 / 37 / 31	49 / 41 / 39 / 32
	Outdoor	Cooling/Heating	54 / 56	55 / 57	57 / 59	54 / 56	55 / 57
		Cooling/Heating	54 / 56	55 / 57	57 / 59	54 / 56	55 / 57
Air flow	Indoor	Cooling (P-Hi/Hi/Me/Lo)	m³/min 37 / 26 / 23 / 17	38 / 28 / 25 / 18	38 / 29 / 26 / 19	37 / 26 / 23 / 17	38 / 28 / 25 / 18
		Heating (P-Hi/Hi/Me/Lo)	37 / 26 / 23 / 17	38 / 28 / 25 / 18	38 / 29 / 26 / 19	37 / 26 / 23 / 17	38 / 28 / 25 / 18
	Outdoor	Cooling/Heating	75 / 73	75 / 73	75 / 73	75 / 73	75 / 73
		Cooling/Heating	75 / 73	75 / 73	75 / 73	75 / 73	75 / 73
Exterior dimensions	Indoor	HeightxWidthxDepth	mm Unit: 298 x 840 x 840 Panel: 35 x 950 x 950				
	Outdoor		845 x 970 x 370				
Net weight	Indoor		kg 30(Unit:25 Standard Panel:5)				
	Outdoor		80		82		
Ref.piping size	Liquid/Gas	ømm	9.52(3/8") / 15.88(5/8")				
Refrigerant line (one way) length		m	Max.50				
Vertical height differences	Outdoor is higher/lower	m	Max.50 / Max.15				
Outdoor operating temperature range	Cooling	°C	-15~50*3				
	Heating		-20~20				
Panel			T-PSA-5AW-E, T-PSAE-5AW-E				
Air filter, Q'ty			Pocket plastic net x 1(Washable)				
Remote control (option)			wired:RC-EX3A, RC-E5, RCH-E3 wireless:RCN-T-5AW-E2				

The values are for simultaneous Multi operation.

		Micro Inverter			
Set model name		FDT100VNAPVG	FDT125VNAPVG	FDT140VNAPVG	FDT140VNATVG
		Twin			Triple
Indoor unit		FDT50VG x 2	FDT60VG x 2	FDT71VG x 2	FDT50VG x 3
Outdoor unit		FDC100VNA	FDC125VNA	FDC140VNA	FDC140VNA
Power source		1 Phase 220-240V, 50Hz / 220V, 60Hz			
Nominal cooling capacity (Min~Max)		kW 10.0 (4.0 ~ 11.2)	12.5 (5.0 ~ 14.0)	13.6 (5.0 ~ 14.5)	13.6 (5.0 ~ 14.5)
Nominal heating capacity (Min~Max)		kW 11.2 (4.0 ~ 12.5)	14.0 (4.0 ~ 16.0)	15.5 (4.0 ~ 16.5)	15.5 (4.0 ~ 16.5)
Power consumption	Cooling/Heating	kW 2.82 / 2.90	3.79 / 3.31	4.22 / 3.29	4.22 / 3.29
EER/COP	Cooling/Heating	3.55 / 3.86	3.30 / 4.23	3.22 / 4.71	3.22 / 4.71
Inrush current		A 5	5	5	5
Max. current		24	24	24	24
Sound power level*1	Indoor*2	Cooling/Heating	54 / 54	60 / 60	62 / 62
	Outdoor	Cooling/Heating	70 / 70	71 / 71	73 / 73
Sound pressure level*1	Indoor*2	Cooling (P-Hi/Hi/Me/Lo)	38 / 33 / 30 / 27	44 / 34 / 32 / 28	46 / 35 / 34 / 29
		Heating (P-Hi/Hi/Me/Lo)	38 / 33 / 30 / 27	44 / 34 / 32 / 28	46 / 35 / 34 / 29
	Outdoor	Cooling/Heating	54 / 56	55 / 57	57 / 59
		Cooling/Heating	54 / 56	55 / 57	57 / 59
Air flow	Indoor*2	Cooling (P-Hi/Hi/Me/Lo)	m³/min 20 / 16 / 13 / 10	26 / 17 / 14 / 11	28 / 18 / 15 / 12
		Heating (P-Hi/Hi/Me/Lo)	20 / 16 / 13 / 10	26 / 17 / 14 / 11	28 / 18 / 15 / 12
	Outdoor	Cooling/Heating	75 / 73	75 / 73	75 / 73
		Cooling/Heating	75 / 73	75 / 73	75 / 73
Exterior dimensions	Indoor	HeightxWidthxDepth	mm Unit: 236 x 840 x 840 Panel: 35 x 950 x 950		
	Outdoor		845 x 970 x 370		
Net weight	Indoor		24(Unit:19 Standard Panel:5)	26(Unit:21 Standard Panel:5)	24(Unit:19 Standard Panel:5)
	Outdoor		80		
Ref.piping size	Liquid/Gas	ømm	9.52(3/8") / 15.88(5/8")		
Refrigerant line (one way) length		m	Max.50		
Vertical height differences	Outdoor is higher/lower	m	Max.50 / Max.15		
Outdoor operating temperature range	Cooling	°C	-15~50*3		
	Heating		-20~20		
Panel			T-PSA-5AW-E, T-PSAE-5AW-E		
Air filter, Q'ty			Pocket plastic net x 1(Washable)		
Remote control (option)			wired:RC-EX3A, RC-E5, RCH-E3 wireless:RCN-T-5AW-E2		

SPECIFICATIONS

The values are for simultaneous Multi operation.

Set model name		Micro Inverter		
		FDT100VSAPVG	FDT125VSAPVG	FDT140VSAPVG
Indoor unit		Twin		
Outdoor unit		FDT50VG x 2	FDT60VG x 2	FDT71VG x 2
Power source		FDC100VSA	FDC125VSA	FDC140VSA
Nominal cooling capacity (Min~Max)		3 Phase 380-415V, 50Hz / 380V, 60Hz		
Nominal heating capacity (Min~Max)		10.0 (4.0 ~ 11.2)	12.5 (5.0 ~ 14.0)	13.6 (5.0 ~ 14.5)
Power consumption		11.2 (4.0 ~ 12.5)	14.0 (4.0 ~ 16.0)	15.5 (4.0 ~ 16.5)
Cooling/Heating		2.82 / 2.90	3.79 / 3.31	4.22 / 3.29
EER/COP		3.55 / 3.86	3.30 / 4.23	3.22 / 4.71
Inrush current		5	5	5
Max. current		15	15	15
Sound power level*1	Indoor*2	54 / 54	60 / 60	62 / 62
	Outdoor	70 / 70	71 / 71	73 / 73
Sound pressure level*1	Indoor*2	38 / 33 / 30 / 27	44 / 34 / 32 / 28	46 / 35 / 34 / 29
	Outdoor	38 / 33 / 30 / 27	44 / 34 / 32 / 28	46 / 35 / 34 / 29
Air flow	Indoor*2	54 / 56	55 / 57	57 / 59
	Outdoor	20 / 16 / 13 / 10	26 / 17 / 14 / 11	28 / 18 / 15 / 12
Exterior dimensions		20 / 16 / 13 / 10	26 / 17 / 14 / 11	28 / 18 / 15 / 12
Net weight		75 / 73	75 / 73	75 / 73
Ref.piping size		Unit: 236 x 840 x 840 Panel: 35 x 950 x 950		
Refrigerant line (one way) length		845 x 970 x 370		
Vertical height differences		24(Unit:19 Standard Panel:5)	26(Unit:21 Standard Panel:5)	
Outdoor operating temperature range		82		
Panel		9.52(3/8") / 15.88(5/8")		
Air filter, Q'ty		Max.50		
Remote control (option)		Max.50 / Max.15		
Inrush current		-15~50*3		
Max. current		-20~20		
Sound power level*1		T-PSA-5AW-E, T-PSAE-5AW-E		
Sound pressure level*1		Pocket plastic net x 1(Washable)		
Air flow		wired:RC-EX3A, RC-E5, RCH-E3 wireless:RCN-T-5AW-E2		

The values are for simultaneous Multi operation.

Set model name		Micro Inverter		
		FDT200VSAPVG	FDT250VSAPVG	FDT140VSATVG
Indoor unit		Twin		
Outdoor unit		FDT100VG x 2	FDT125VG x 2	FDT50VG x 3
Power source		FDC200VSA	FDC250VSA	FDC140VSA
Nominal cooling capacity (Min~Max)		3 Phase 380-415V, 50Hz / 380V, 60Hz		
Nominal heating capacity (Min~Max)		19.0 (5.2 ~ 22.4)	24.0 (6.9 ~ 28.0)	13.6 (5.0 ~ 14.5)
Power consumption		22.4 (3.3 ~ 25.0)	27.0 (5.5 ~ 31.5)	15.5 (4.0 ~ 16.5)
Cooling/Heating		6.25 / 6.02	8.36 / 7.15	4.22 / 3.29
EER/COP		3.04 / 3.72	2.87 / 3.78	3.22 / 4.71
Inrush current		5	5	5
Max. current		20	21	15
Sound power level*1	Indoor*2	63 / 63	64 / 64	54 / 54
	Outdoor	72 / 74	73 / 75	73 / 73
Sound pressure level*1	Indoor*2	48 / 39 / 37 / 31	49 / 41 / 39 / 32	38 / 33 / 30 / 27
	Outdoor	48 / 39 / 37 / 31	49 / 41 / 39 / 32	38 / 33 / 30 / 27
Air flow	Indoor*2	58 / 59	59 / 62	57 / 59
	Outdoor	37 / 26 / 23 / 17	38 / 28 / 25 / 18	20 / 16 / 13 / 10
Exterior dimensions		37 / 26 / 23 / 17	38 / 28 / 25 / 18	20 / 16 / 13 / 10
Net weight		135 / 135	143 / 151	75 / 73
Ref.piping size		Unit: 298 x 840 x 840 Panel: 35 x 950 x 950		
Refrigerant line (one way) length		Unit: 236 x 840 x 840 Panel: 35 x 950 x 950		
Vertical height differences		845 x 970 x 370		
Outdoor operating temperature range		1,300 x 970 x 370		
Panel		1,505 x 970 x 370		
Air filter, Q'ty		30(Unit:25 Standard Panel:5)		
Remote control (option)		24(Unit:19 Standard Panel:5)		
Inrush current		115		
Max. current		143		
Sound power level*1		9.52(3/8") / 22.22(7/8")		
Sound pressure level*1		12.7(1/2") / 22.22(7/8")		
Air flow		9.52(3/8") / 15.88(5/8")		
Exterior dimensions		Max.70		
Net weight		Max.30 / Max.15		
Ref.piping size		-15~50*3		
Refrigerant line (one way) length		-15~20		
Vertical height differences		-20~20		
Outdoor operating temperature range		T-PSA-5AW-E, T-PSAE-5AW-E		
Panel		Pocket plastic net x 1(Washable)		
Air filter, Q'ty		wired:RC-EX3A, RC-E5, RCH-E3 wireless:RCN-T-5AW-E2		
Remote control (option)				

NOTES:

The data are measured under the following conditions(ISO-T1).
 Cooling:Indoor temp. of 27°CDB, 19°CWB, and outdoor temp. of 35°CDB. Heating:Indoor temp. of 20°CDB, and outdoor temp. of 7°CDB, 6°CWB.
 *1 : Indicates the value in an anechoic chamber. During operation these values are somewhat higher due to ambient conditions.
 *2 : The values are for one indoor unit operation. (Multi system only)
 *3 : If a cooling operation is conducted when the outdoor air temperature is -5°C or lower, the outdoor unit should be installed at a place where it is not influenced by natural wind. If wind blows, the low pressure will drop and compressor frequency will increase, this will cause the capacity to drop and may cause the unit to break down.

SPECIFICATIONS

The values are for simultaneous Multi operation.

Set model name		Micro Inverter			
		FDT200VSATVG	FDT200VSADVG	FDT250VSADVG	
		Triple	Double Twin		
Indoor unit		FDT71VG x 3	FDT50VG x 4	FDT60VG x 4	
Outdoor unit		FDC200VSA	FDC200VSA	FDC250VSA	
Power source		3 Phase 380-415V, 50Hz / 380V, 60Hz			
Nominal cooling capacity (Min~Max)	kW	19.0 (5.2 ~ 22.4)	19.0 (5.2 ~ 22.4)	24.0 (6.9 ~ 28.0)	
Nominal heating capacity (Min~Max)	kW	22.4 (3.3 ~ 25.0)	22.4 (3.3 ~ 25.0)	27.0 (5.5 ~ 31.5)	
Power consumption	Cooling/Heating kW	6.01 / 5.76	6.26 / 6.15	7.42 / 6.83	
EER/COP	Cooling/Heating	3.16 / 3.89	3.04 / 3.64	3.23 / 3.95	
Inrush current	A	5	5	5	
Max. current		20	20	21	
Sound power level*1	Indoor*2	Cooling/Heating	62 / 62	54 / 54	60 / 60
	Outdoor	Cooling/Heating	72 / 74	72 / 74	73 / 75
Sound pressure level*1	Indoor*2	Cooling (P-Hi/Hi/Me/Lo)	46 / 35 / 34 / 29	38 / 33 / 30 / 27	44 / 34 / 32 / 28
		Heating (P-Hi/Hi/Me/Lo)	46 / 35 / 34 / 29	38 / 33 / 30 / 27	44 / 34 / 32 / 28
	Outdoor	Cooling/Heating	58 / 59	58 / 59	59 / 62
		Cooling/Heating	135 / 135	135 / 135	143 / 151
Air flow	Indoor*2	Cooling (P-Hi/Hi/Me/Lo)	28 / 18 / 15 / 12	20 / 16 / 13 / 10	26 / 17 / 14 / 11
		Heating (P-Hi/Hi/Me/Lo)	28 / 18 / 15 / 12	20 / 16 / 13 / 10	26 / 17 / 14 / 11
	Outdoor	Cooling/Heating	135 / 135	135 / 135	143 / 151
Exterior dimensions	Indoor	HeightxWidthxDepth	Unit: 236 x 840 x 840 Panel: 35 x 950 x 950		
	Outdoor		1,300 x 970 x 370		
Net weight	Indoor	kg	26(Unit:21 Standard Panel:5)	24(Unit:19 Standard Panel:5)	26(Unit:21 Standard Panel:5)
	Outdoor		115		143
Ref.piping size	Liquid/Gas	ømm	9.52(3/8") / 22.22(7/8")		12.7(1/2") / 22.22(7/8")
Refrigerant line (one way) length		m	Max.70		
Vertical height differences	Outdoor is higher/lower	m	Max.30 / Max.15		
Outdoor operating temperature range	Cooling	°C	-15~50*3		
	Heating		-15~20		
Panel			T-PSA-5AW-E, T-PSAE-5AW-E		
Air filter, Q'ty			Pocket plastic net x 1(Washable)		
Remote control (option)			wired:RC-EX3A, RC-E5, RCH-E3 wireless:RCN-T-5AW-E2		

Set model name		Standard Inverter				
		FDT71VNPVG	FDT90VNP1VG	FDT100VNP1VG		
		FDT71VNP	FDC90VNP1	FDC100VNP		
Indoor unit		FDT71VG	FDT100VG	FDT100VG		
Outdoor unit		FDC71VNP	FDC90VNP1	FDC100VNP		
Power source		1 Phase 220-240V, 50Hz / 220V, 60Hz				
Nominal cooling capacity (Min~Max)	kW	7.1 (1.4 ~ 7.1)	9.0 (1.9 ~ 9.0)	10.0 (2.8 ~ 11.2)		
Nominal heating capacity (Min~Max)	kW	7.1 (1.0 ~ 7.1)	9.0 (1.5 ~ 9.0)	11.2 (2.5 ~ 12.5)		
Power consumption	Cooling/Heating kW	2.31 / 1.73	2.67 / 2.19	2.76 / 2.84		
EER/COP	Cooling/Heating	3.07 / 4.10	3.37 / 4.11	3.62 / 3.94		
Inrush current	A	5	5	5		
Max. current		14.5	18.0	21.0		
Sound power level*1	Indoor	Cooling/Heating	62 / 62	63 / 63	63 / 63	
	Outdoor	Cooling/Heating	67 / 67	69 / 69	70 / 70	
Sound pressure level*1	Indoor	Cooling (P-Hi/Hi/Me/Lo)	46 / 35 / 34 / 29	48 / 39 / 37 / 31	48 / 39 / 37 / 31	
		Heating (P-Hi/Hi/Me/Lo)	46 / 35 / 34 / 29	48 / 39 / 37 / 31	48 / 39 / 37 / 31	
	Outdoor	Cooling/Heating	54 / 54	57 / 55	57 / 61	
		Cooling/Heating	28 / 18 / 15 / 12	37 / 26 / 23 / 17	37 / 26 / 23 / 17	
Air flow	Indoor	Cooling (P-Hi/Hi/Me/Lo)	28 / 18 / 15 / 12	37 / 26 / 23 / 17	37 / 26 / 23 / 17	
		Heating (P-Hi/Hi/Me/Lo)	28 / 18 / 15 / 12	37 / 26 / 23 / 17	37 / 26 / 23 / 17	
	Outdoor	Cooling/Heating	36 / 36	63 / 49.5	75 / 79	
Exterior dimensions	Indoor	HeightxWidthxDepth	Unit: 236 x 840 x 840 Panel: 35 x 950 x 950			
	Outdoor		640 x 800(+71) x 290			
Net weight	Indoor	kg	26(Unit:21 Standard Panel:5)	30(Unit:25 Standard Panel:5)	70	
	Outdoor		45		57	
Ref.piping size	Liquid/Gas	ømm	6.35(1/4") / 12.7(1/2")		6.35(1/4") / 15.88(5/8")	9.52(3/8") / 15.88(5/8")
Refrigerant line (one way) length		m	Max.30			
Vertical height differences	Outdoor is higher/lower	m	Max.20 / Max.20			
Outdoor operating temperature range	Cooling	°C	-15~46*3			
	Heating		-15~20			
Panel			T-PSA-5AW-E, T-PSAE-5AW-E			
Air filter, Q'ty			Pocket Plastic net x1(Washable)			
Remote control (option)			wired:RC-EX3A, RC-E5, RCH-E3 wireless:RCN-T-5AW-E2			

CEILING CASSETTE -4way Compact

FDTC

NEW



FDTC 40/50/60

Draft Prevention Panel (option)

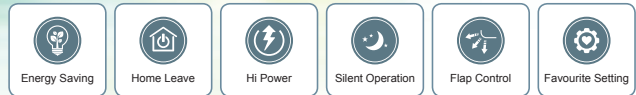

*Not all functions available with all remote control options.

Remote control (option)

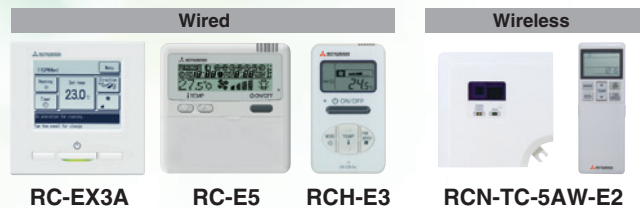

Point 1 European design & Flat panel

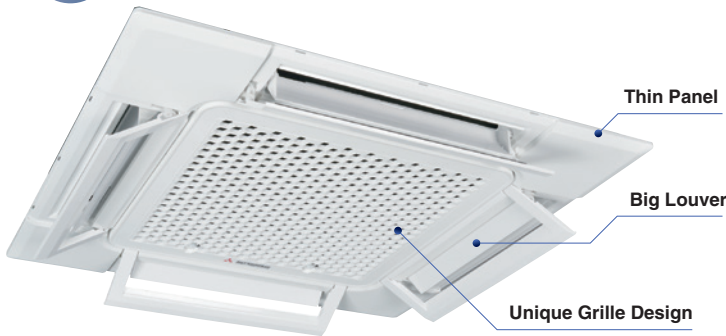

Integrated ceiling system design

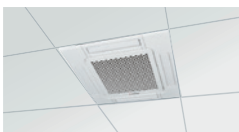

A grille designed with a unique structure and a clean white panel harmonize with interior. This design was invented by zweigrad GmbH & Co. KG in Germany.

Compact Design

□700mm → □620mm

A weight of only 14kg. Height of thin panel and main body is only 248 mm allowing it to be a very easy installation.



Taking OA (Outside Air) into inside

Fresh air can be taken in without option parts. When it is insufficient, existing option parts also can be used.

OA Spacer TC-OAS-E2(option)
Joint Duct TC-OAD-E(option)

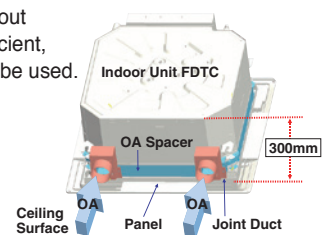

Point 2 Draft Prevention Panel (Option)

Draft Prevention Panel prevents cold/hot draft being blown directly on the user. It is possible to set Draft Prevention Panel for each air outlet.

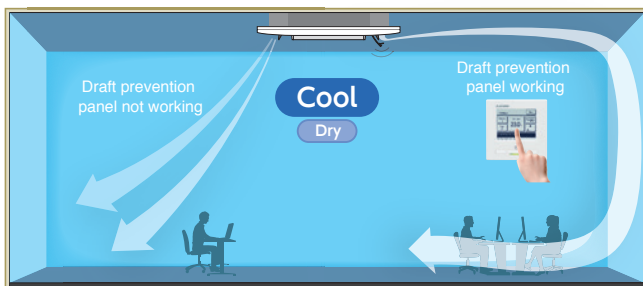

User can position Draft Prevention Panel panels by using the remote controller only (RC-EX3A, RCN-TC-5AW-E2).

Point 3 Motion Sensor (Option)

Motion sensor is equipped in the panel corner and detects the presence/absence and activity of humans in a room to improve the comfort and energy saving performance of the unit.



LB-TC-5W-E

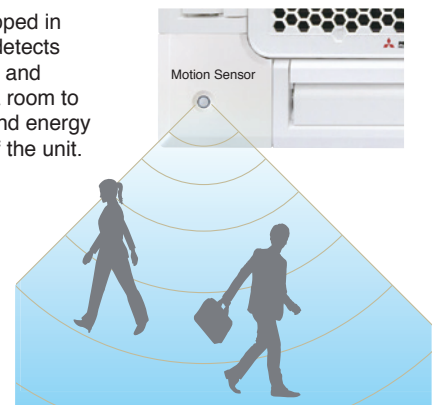

Point 4 Individual flap control system

According to room temperature conditions, four directions of air flow can be controlled

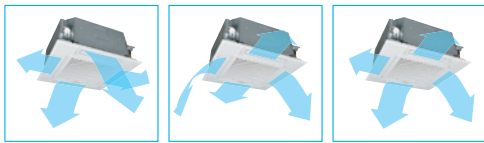

individually by following Flap control system. Individual flap control is available even after installation.

The flap can swing within the range of upper and lower flap position selected with wired remote control.

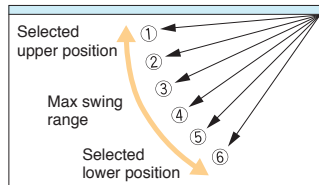

*The wireless remote control is not applicable to the Individual flap control system.

Point 5 850mm Drain Pump

Drain can be discharged upward by 850 mm from the ceiling surface close to the indoor unit. It allows a piping layout with a high degree of freedom depending on the installation location.

Point 6 Quiet operation

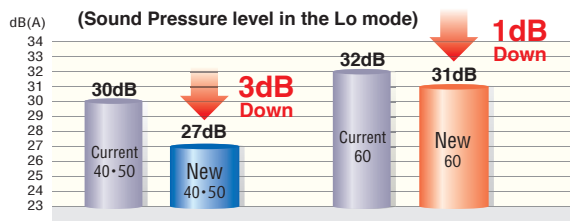

Point 7 Panel select pattern

8 patterns of panel are available. Please refer to P27.

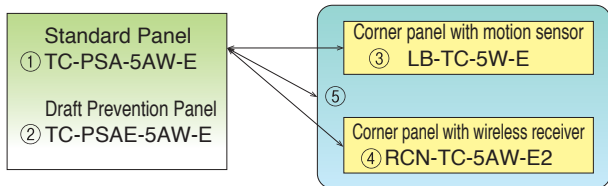

OUTDOOR UNIT

SRC • FDC	Hyper Inverter			Micro Inverter		
	40~60ZSX	71VNX	100~140VN(S)X	100~140VN(S)A	200VSA	250VSA
model						
Chargeless	15m	30m		30m		
Height x Width x Depth (mm)	640 x 800(+71) x 290	750 x 880(+88) x 340	1,300 x 970 x 370	845 x 970 x 370	1,300 x 970 x 370	1,505 x 970 x 370

DIMENSIONS (Unit:mm)

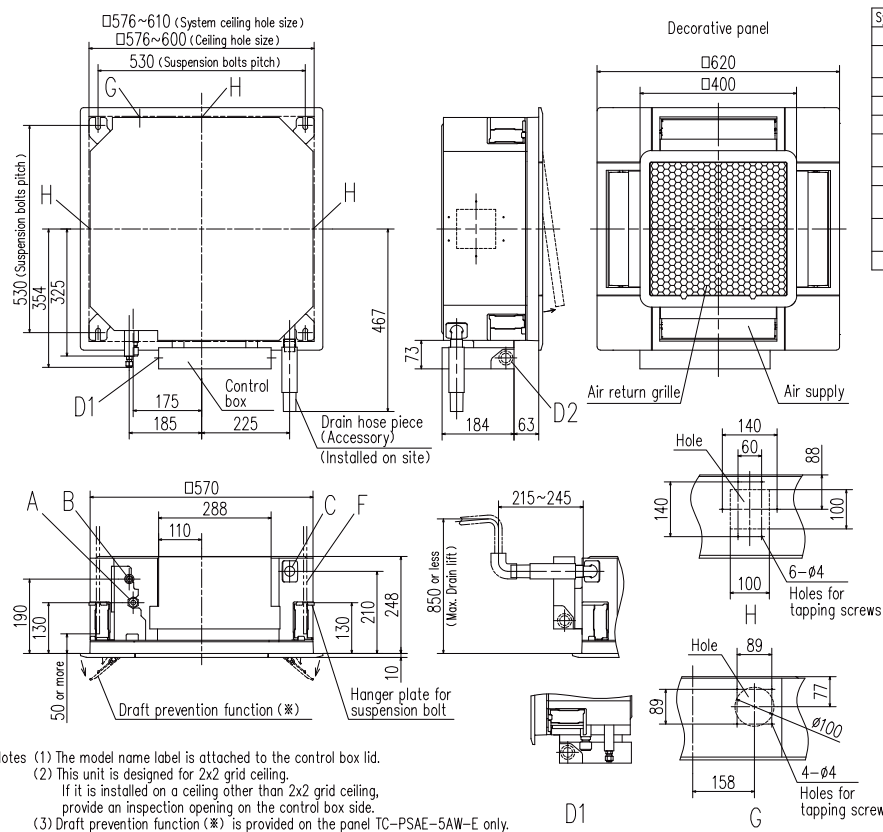

Symbol	Content	
Model	25,35	40,50,60
A	Gas piping #9.52 (3/8") (Flare)	#12.7 (1/2") (Flare)
B	Liquid piping #6.35 (1/4") (Flare)	
C	Drain piping VP25 (O.D.32)	
D1	Power supply connection	
D2	Remote control code and signal wiring connection	
F	Suspension bolts (M10 or M8)	
G	Outside air opening for ducting (Knock out)	
H	Air outlet opening for ducting #125 (Knock out)	
J	Inspection opening 450X450	

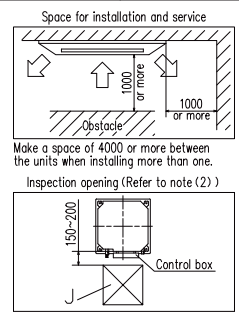

- Notes (1) The model name label is attached to the control box lid.
- (2) This unit is designed for 2x2 grid ceiling. If it is installed on a ceiling other than 2x2 grid ceiling, provide an inspection opening on the control box side.
- (3) Draft prevention function (*) is provided on the panel TC-PSAE-5AW-E only.

SPECIFICATIONS

		Hyper Inverter			
Set model name		FDTC40ZSXVG	FDTC50ZSXVG	FDTC60ZSXVG	
Indoor unit		FDTC40VG	FDTC50VG	FDTC60VG	
Outdoor unit		SRC40ZSX-S	SRC50ZSX-S	SRC60ZSX-S	
Power source		1 Phase 220-240V, 50Hz / 220V, 60Hz			
Nominal cooling capacity (Min~Max)	kW	4.0 (1.1 ~ 4.7)	5.0 (1.1 ~ 5.6)	5.6 (1.1 ~ 6.3)	
Nominal heating capacity (Min~Max)	kW	4.5 (0.6 ~ 5.4)	5.4 (0.6 ~ 6.3)	6.7 (0.6 ~ 6.7)	
Power consumption	Cooling/Heating kW	0.98 / 1.13	1.43 / 1.53	1.76 / 2.14	
EER/COP	Cooling/Heating	4.08 / 3.98	3.50 / 3.53	3.18 / 3.13	
Inrush current	A	5	5	5	
Max. current		12	15	15	
Sound power level*1	Indoor	Cooling/Heating	59 / 59	59 / 59	60 / 60
	Outdoor	Cooling/Heating	63 / 63	63 / 63	65 / 64
Sound pressure level*1	Indoor	Cooling (P-Hi/Hi/Me/Lo)	44 / 40 / 35 / 27	44 / 40 / 35 / 27	46 / 42 / 38 / 31
		Heating (P-Hi/Hi/Me/Lo)	44 / 40 / 35 / 27	44 / 40 / 35 / 27	46 / 42 / 38 / 31
	Outdoor	Cooling/Heating	50 / 49	50 / 49	52 / 52
		Cooling/Heating	13 / 11 / 9 / 7	13 / 11 / 9 / 7	14 / 12 / 10 / 8
Air flow	Indoor	Cooling (P-Hi/Hi/Me/Lo)	13 / 11 / 9 / 7	13 / 11 / 9 / 7	14 / 12 / 10 / 8
		Heating (P-Hi/Hi/Me/Lo)	13 / 11 / 9 / 7	13 / 11 / 9 / 7	14 / 12 / 10 / 8
	Outdoor	Cooling/Heating	36 / 33	40 / 33	41.5 / 39
Exterior dimensions	Indoor	HeightxWidthxDepth	Unit: 248 x 570 x 570 Panel: 10 x 620 x 620		
	Outdoor		640 x 800(+71) x 290		
Net weight	Indoor		16.5(Unit:14 Standard Panel:2.5)		
	Outdoor		45		
Ref.piping size	Liquid/Gas		6.35(1/4") / 12.7(1/2")		
Refrigerant line (one way) length			Max.30		
Vertical height differences	Outdoor is higher/lower		Max.20 / Max.20		
Outdoor operating temperature range	Cooling		-15~-46*3		
	Heating		-20~-24		
Panel			TC-PSA-5AW-E, TC-PSAE-5AW-E		
Air filter, Q'ty			Pocket plastic net x 1(Washable)		
Remote control (option)			wired:RC-EX3A, RC-E5, RCH-E3 wireless:RCN-TC-5AW-E2		

The values are for simultaneous Multi operation.

		Hyper Inverter						
Set model name		FDTC71VNX	FDTC100VNX	FDTC125VNX	FDTC140VNX	FDTC100VXS	FDTC125VXS	FDTC140VXS
		Twin			Triple	Twin		Triple
Indoor unit		FDTC40VG x 2	FDTC50VG x 2	FDTC60VG x 2	FDTC50VG x 3	FDTC50VG x 2	FDTC60VG x 2	FDTC50VG x 3
Outdoor unit		FDC71VNX	FDC100VNX	FDC125VNX	FDC140VNX	FDC100VXS	FDC125VXS	FDC140VXS
Power source		1 Phase 220-240V, 50Hz / 220V, 60Hz				3 Phase 380-415V, 50Hz / 380V, 60Hz		
Nominal cooling capacity (Min~Max)	kW	7.1 (3.2 ~ 8.0)	10.0 (4.0 ~ 11.2)	12.5 (5.0 ~ 14.0)	14.0 (5.0 ~ 16.0)	10.0 (4.0 ~ 11.2)	12.5 (5.0 ~ 14.0)	14.0 (5.0 ~ 16.0)
Nominal heating capacity (Min~Max)	kW	8.0 (3.6 ~ 9.0)	11.2 (4.0 ~ 12.5)	14.0 (4.0 ~ 17.0)	16.0 (4.0 ~ 18.0)	11.2 (4.0 ~ 16.0)	14.0 (4.0 ~ 18.0)	16.0 (4.0 ~ 20.0)
Power consumption	Cooling/Heating kW	2.03 / 1.64	2.80 / 3.50	4.10 / 4.10	4.20 / 4.34	2.80 / 3.50	4.10 / 4.10	4.20 / 4.34
EER/COP	Cooling/Heating	3.50 / 4.88	3.57 / 3.20	3.05 / 3.41	3.33 / 3.69	3.57 / 3.20	3.05 / 3.41	3.33 / 3.69
Inrush current	A	5	5	5	5	5	5	5
Max. current		17	24	24	26	15	15	15
Sound power level*1	Indoor*2	Cooling/Heating	59 / 59	59 / 59	60 / 60	59 / 59	59 / 59	60 / 60
	Outdoor	Cooling/Heating	66 / 66	70 / 70	70 / 70	72 / 72	70 / 70	70 / 70
Sound pressure level*1	Indoor*2	Cooling (P-Hi/Hi/Me/Lo)	44 / 40 / 35 / 27	44 / 40 / 35 / 27	46 / 42 / 38 / 31	44 / 40 / 35 / 27	44 / 40 / 35 / 27	46 / 42 / 38 / 31
		Heating (P-Hi/Hi/Me/Lo)	44 / 40 / 35 / 27	44 / 40 / 35 / 27	46 / 42 / 38 / 31	44 / 40 / 35 / 27	44 / 40 / 35 / 27	46 / 42 / 38 / 31
	Outdoor	Cooling/Heating	51 / 48	48 / 50	48 / 50	49 / 52	48 / 50	48 / 50
		Cooling/Heating	13 / 11 / 9 / 7	13 / 11 / 9 / 7	14 / 12 / 10 / 8	13 / 11 / 9 / 7	13 / 11 / 9 / 7	14 / 12 / 10 / 8
Air flow	Indoor*2	Cooling (P-Hi/Hi/Me/Lo)	13 / 11 / 9 / 7	13 / 11 / 9 / 7	14 / 12 / 10 / 8	13 / 11 / 9 / 7	13 / 11 / 9 / 7	14 / 12 / 10 / 8
		Heating (P-Hi/Hi/Me/Lo)	13 / 11 / 9 / 7	13 / 11 / 9 / 7	14 / 12 / 10 / 8	13 / 11 / 9 / 7	13 / 11 / 9 / 7	14 / 12 / 10 / 8
	Outdoor	Cooling/Heating	60 / 50	100 / 100	100 / 100	100 / 100	100 / 100	100 / 100
Exterior dimensions	Indoor	HeightxWidthxDepth	Unit: 248 x 570 x 570 Panel: 10 x 620 x 620					
	Outdoor		750 x 880(+88) x 340					
Net weight	Indoor		16.5(Unit:14 Standard Panel:2.5)					
	Outdoor		105					
Ref.piping size	Liquid/Gas		9.52(3/8") / 15.88(5/8")					
Refrigerant line (one way) length		Max.50	Max.100					
Vertical height differences	Outdoor is higher/lower		Max.30 / Max.15					
Outdoor operating temperature range	Cooling		-15~-43*3					
	Heating		-20~-20					
Panel			TC-PSA-5AW-E, TC-PSAE-5AW-E					
Air filter, Q'ty			Pocket plastic net x 1(Washable)					
Remote control (option)			wired:RC-EX3A, RC-E5, RCH-E3 wireless:RCN-TC-5AW-E2					

NOTES:

The data are measured under the following conditions(ISO-T1).
Cooling:Indoor temp. of 27°CDB, 19°CWB, and outdoor temp. of 35°CDB. Heating:Indoor temp. of 20°CDB, and outdoor temp. of 7°CDB, 6°CWB.
*1 : Indicates the value in an anechoic chamber. During operation these values are somewhat higher due to ambient conditions.
*2 : The values are for one indoor unit operation. (Multi system only)
*3 : If a cooling operation is conducted when the outdoor air temperature is -5°C or lower, the outdoor unit should be installed at a place where it is not influenced by natural wind. If wind blows, the low pressure will drop and compressor frequency will increase, this will cause the capacity to drop and may cause the unit to break down.

SPECIFICATIONS

The values are for simultaneous Multi operation.

Set model name		Micro Inverter			
		FDTC100VNAPVG	FDTC125VNAPVG	FDTC140VNATVG	
		Twin		Triple	
Indoor unit		FDTC50VG x 2	FDTC60VG x 2	FDTC50VG x 3	
Outdoor unit		FDC100VNA	FDC125VNA	FDC140VNA	
Power source		1 Phase 220-240V, 50Hz / 220V, 60Hz			
Nominal cooling capacity (Min~Max)	kW	10.0 (4.0 ~ 11.2)	12.5 (5.0 ~ 14.0)	13.6 (5.0 ~ 14.5)	
Nominal heating capacity (Min~Max)	kW	11.2 (4.0 ~ 12.5)	14.0 (4.0 ~ 16.0)	15.5 (4.0 ~ 16.5)	
Power consumption	Cooling/Heating kW	3.30 / 3.15	4.90 / 4.50	4.75 / 4.60	
EER/COP	Cooling/Heating	3.03 / 3.56	2.55 / 3.11	2.86 / 3.37	
Inrush current		5	5	5	
Max. current		25	25	25	
Sound power level*1	Indoor*2	Cooling/Heating	59 / 59	60 / 60	59 / 59
	Outdoor	Cooling/Heating	70 / 70	71 / 71	73 / 73
Sound pressure level*1	Indoor*2	Cooling (P-Hi/Hi/Me/Lo)	44 / 40 / 35 / 27	46 / 42 / 38 / 31	44 / 40 / 35 / 27
		Heating (P-Hi/Hi/Me/Lo)	44 / 40 / 35 / 27	46 / 42 / 38 / 31	44 / 40 / 35 / 27
	Outdoor	Cooling/Heating	54 / 56	55 / 57	57 / 59
		Cooling/Heating	75 / 73	75 / 73	75 / 73
Air flow	Indoor*2	Cooling (P-Hi/Hi/Me/Lo)	13 / 11 / 9 / 7	14 / 12 / 10 / 8	13 / 11 / 9 / 7
		Heating (P-Hi/Hi/Me/Lo)	13 / 11 / 9 / 7	14 / 12 / 10 / 8	13 / 11 / 9 / 7
	Outdoor	Cooling/Heating	75 / 73	75 / 73	75 / 73
		Cooling/Heating	75 / 73	75 / 73	75 / 73
Exterior dimensions	Indoor	HeightxWidthxDepth	Unit: 248 x 570 x 570 Panel: 10 x 620 x 620		
	Outdoor	HeightxWidthxDepth	845 x 970 x 370		
Net weight	Indoor		16.5(Unit:14 Standard Panel:2.5)		
	Outdoor		80		
Ref.piping size	Liquid/Gas		9.52(3/8") / 15.88(5/8")		
Refrigerant line (one way) length			Max.50		
Vertical height differences	Outdoor is higher/lower		Max.50 / Max.15		
Outdoor operating temperature range	Cooling		-15~50*3		
	Heating		-20~20		
Panel			TC-PSA-5AW-E, TC-PSAE-5AW-E		
Air filter, Q'ty			Pocket plastic net x 1(Washable)		
Remote control (option)			wired:RC-EX3A, RC-E5, RCH-E3, wireless:RCN-TC-5AW-E2		

The values are for simultaneous Multi operation.

Set model name		Micro Inverter					
		FDTC100VSAPVG	FDTC125VSAPVG	FDTC140VSATVG	FDTC200VSADVG	FDTC250VSADVG	
		Twin		Triple	Double Twin		
Indoor unit		FDTC50VG x 2	FDTC60VG x 2	FDTC50VG x 3	FDTC50VG x 4	FDTC60VG x 4	
Outdoor unit		FDC100VSA	FDC125VSA	FDC140VSA	FDC200VSA	FDC250VSA	
Power source		3 Phase 380-415V, 50Hz / 380V, 60Hz					
Nominal cooling capacity (Min~Max)	kW	10.0 (4.0 ~ 11.2)	12.5 (5.0 ~ 14.0)	13.6 (5.0 ~ 14.5)	19.0 (5.2 ~ 22.4)	24.0 (6.9 ~ 28.0)	
Nominal heating capacity (Min~Max)	kW	11.2 (4.0 ~ 12.5)	14.0 (4.0 ~ 16.0)	15.5 (4.0 ~ 16.5)	22.4 (3.3 ~ 25.0)	27.0 (5.5 ~ 31.5)	
Power consumption	Cooling/Heating kW	3.30 / 3.15	4.90 / 4.50	4.75 / 4.60	6.95 / 10.7	6.79 / 8.20	
EER/COP	Cooling/Heating	3.03 / 3.56	2.55 / 3.11	2.86 / 3.37	2.73 / 2.10	3.53 / 3.29	
Inrush current		5	5	5	5	5	
Max. current		15	15	15	20	21	
Sound power level*1	Indoor*2	Cooling/Heating	59 / 59	60 / 60	59 / 59	59 / 59	60 / 60
	Outdoor	Cooling/Heating	70 / 70	71 / 71	73 / 73	72 / 74	75 / 75
Sound pressure level*1	Indoor*2	Cooling (P-Hi/Hi/Me/Lo)	44 / 40 / 35 / 27	46 / 42 / 38 / 31	44 / 40 / 35 / 27	44 / 40 / 35 / 27	46 / 42 / 38 / 31
		Heating (P-Hi/Hi/Me/Lo)	44 / 40 / 35 / 27	46 / 42 / 38 / 31	44 / 40 / 35 / 27	44 / 40 / 35 / 27	46 / 42 / 38 / 31
	Outdoor	Cooling/Heating	54 / 56	55 / 57	57 / 59	58 / 59	61 / 62
		Cooling/Heating	75 / 73	75 / 73	75 / 73	135 / 135	143 / 151
Air flow	Indoor*2	Cooling (P-Hi/Hi/Me/Lo)	13 / 11 / 9 / 7	14 / 12 / 10 / 8	13 / 11 / 9 / 7	13 / 11 / 9 / 7	14 / 12 / 10 / 8
		Heating (P-Hi/Hi/Me/Lo)	13 / 11 / 9 / 7	14 / 12 / 10 / 8	13 / 11 / 9 / 7	13 / 11 / 9 / 7	14 / 12 / 10 / 8
	Outdoor	Cooling/Heating	75 / 73	75 / 73	75 / 73	135 / 135	143 / 151
		Cooling/Heating	75 / 73	75 / 73	75 / 73	135 / 135	143 / 151
Exterior dimensions	Indoor	HeightxWidthxDepth	Unit: 248 x 570 x 570 Panel: 10 x 620 x 620				
	Outdoor	HeightxWidthxDepth	845 x 970 x 370		1,300 x 970 x 370		1,505 x 970 x 370
Net weight	Indoor		16.5(Unit:14 Standard Panel:2.5)				
	Outdoor		82		115		143
Ref.piping size	Liquid/Gas		9.52(3/8") / 15.88(5/8")			9.52(3/8") / 22.22(7/8")	12.7(1/2") / 22.22(7/8")
Refrigerant line (one way) length			Max.50				
Vertical height differences	Outdoor is higher/lower		Max.50 / Max.15		Max.30 / Max.15		
Outdoor operating temperature range	Cooling		-15~50*3				
	Heating		-20~20		-15~20		
Panel			TC-PSA-5AW-E, TC-PSAE-5AW-E				
Air filter, Q'ty			Pocket plastic net x 1(Washable)				
Remote control (option)			wired:RC-EX3A, RC-E5, RCH-E3 wireless:RCN-TC-5AW-E2				

DUCT CONNECTED -High Static pressure- FDU



FDU 71/100/125/140

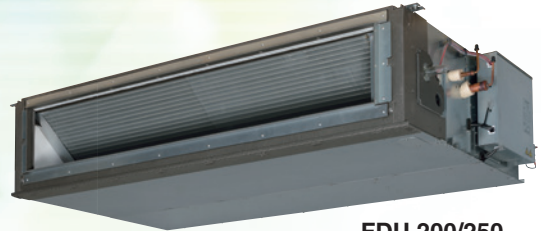

FDU 200/250
Tropical Usage Mode

Remote control (option)

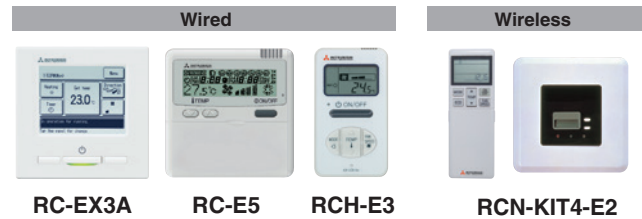

*Not all functions are available with all remote control options.

Point 1 Automatic external static pressure (E.S.P.) control

You can set External Static Pressure (E.S.P.) by method of manual setting on remote control. Indoor unit will control fan-speed to keep rated air flow volume at each fan speed setting. You can set required E.S.P. by wired remote control that calculated with the set air flow rate and pressure loss of the duct connected.

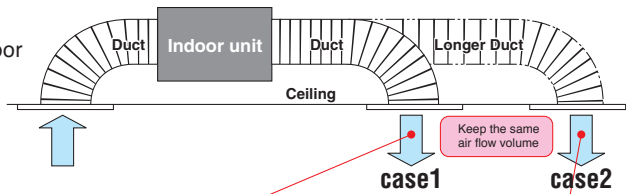

Expansion of external static pressure range

Previous
10~130Pa

Current
10~200Pa

RC-E5 E.S.P. button

External Static Pressure (E.S.P.) can be set by E.S.P. button.



Setting No.	No.8	No.9	No.10	No.11	No.12	No.13	No.14	No.15
E.S.P.	80Pa	90Pa	100Pa	110Pa	120Pa	130Pa	140Pa	150Pa

*Range of 80~150 Pa is set at ex-factory default.
Range of 10~200 Pa is available by setting SW8-4 switch on at site.

Point 2 More quiet noise

Thanks to use of DC fan motor, fan steps increase from two to four and quiet operation is achieved.(FDU200/250)

	Previous	Current	Lo mode
FDU71	37	➔ 25	12dB(A) less!!
FDU100	38	➔ 30	8dB(A) less!!
FDU200	51	➔ 45	6dB(A) less!!

Point 3 High efficiency

Energy efficiency is improved by use of DC fan motor & high efficient heat exchanger.

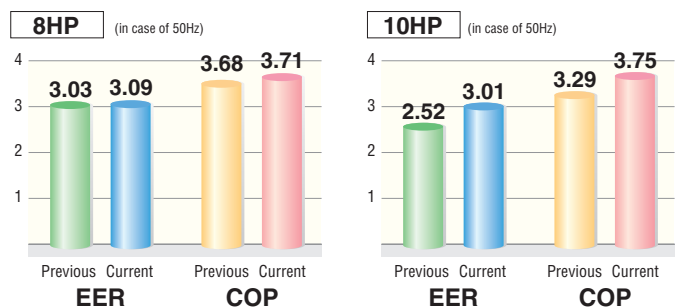

Point 4 Improvement of the serviceability

Fan unit (impeller and motor) can be pulled out from the right side of the unit. Maintenance can be available from the right side or the bottom side.

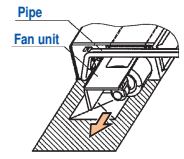

Point 6 Transparent inspection window

Dirt condition of the bottom of a drain pan can be checked through this transparent inspection window without removing drain pan.

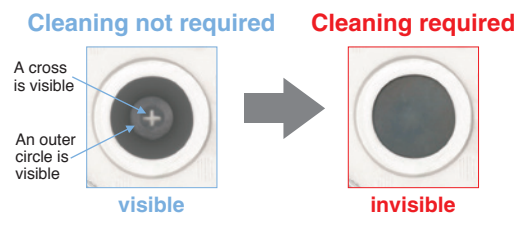

Point 5 Enhanced installation workability

600mm Drain Pump is mounted in FDU71/100/125/140. The indoor unit is completely hidden in the ceiling, so this is suitable for spaces with classy interior decoration.

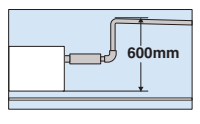

Round duct adapter (Available for FDU71~140VF)

AIRZONE Company: AIRZONE
URL: <http://www.airzone.es>

All-in-one solution: the whole zoning system in a plug&play device perfectly adapted to the indoor DX unit

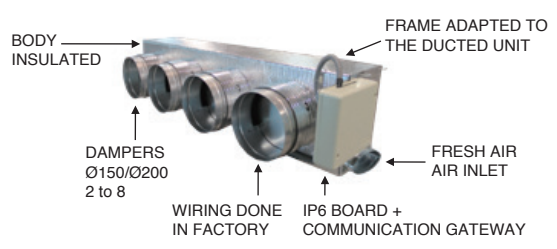

Main components

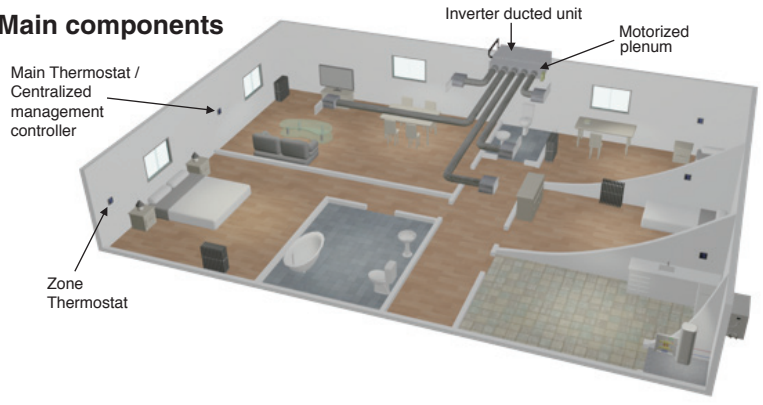

OUTDOOR UNIT

FDC	Hyper Inverter		Micro Inverter		
	71VNX	100~140VN(S)X	100~140VN(S)A	200VSA	250VSA
model					
Chargeless	30m		30m		
Height x Width x Depth (mm)	750 x 880(+88) x 340	1,300 x 970 x 370	845 x 970 x 370	1,300 x 970 x 370	1,505 x 970 x 370

FDC	Standard Inverter		
	71VNP	90VNP1	100VNP
model			
Chargeless	15m		
Height x Width x Depth (mm)	640 x 800(+71) x 290	750 x 880(+88) x 340	845 x 970 x 370

DIMENSIONS (Unit:mm)

Model FDU71VF1

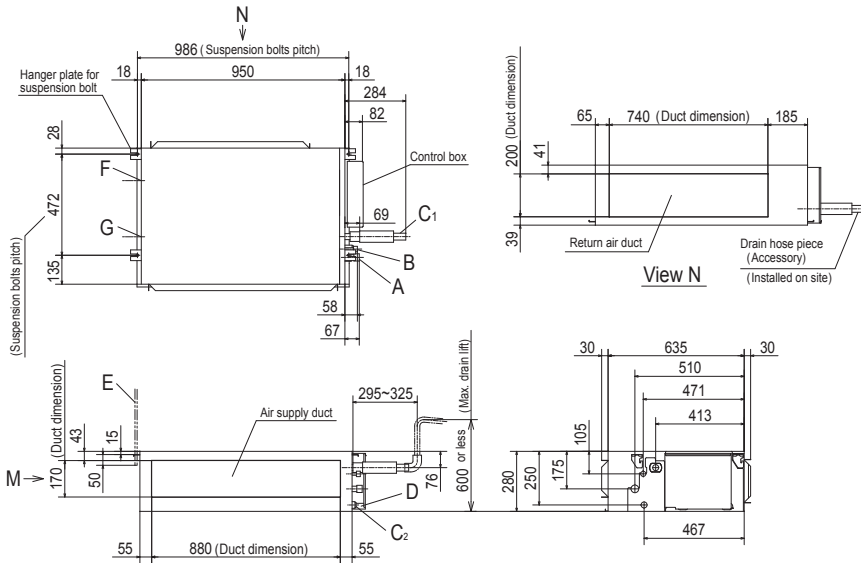

Symbol	Content	
A	Gas piping	φ 15.88 (5/8") (Flare)
B	Liquid piping	φ 9.52 (3/8") (Flare)
C1	Drain piping	VP25 (I.D.25,O.D.32)
C2	Drain piping (Gravity drainage)	VP20 (I.D.20,O.D.26)
D	Hole for wiring	
E	Suspension bolts	(M10)
F	Outside air opening for ducting	(Knock out)
G	Air outlet opening for ducting	(Knock out)
H	Inspection hole	(450X450)

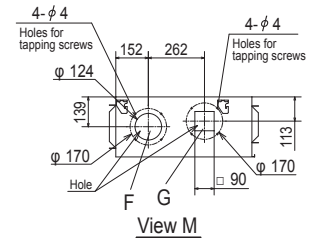

Models FDU100VF2, 125VF, 140VF

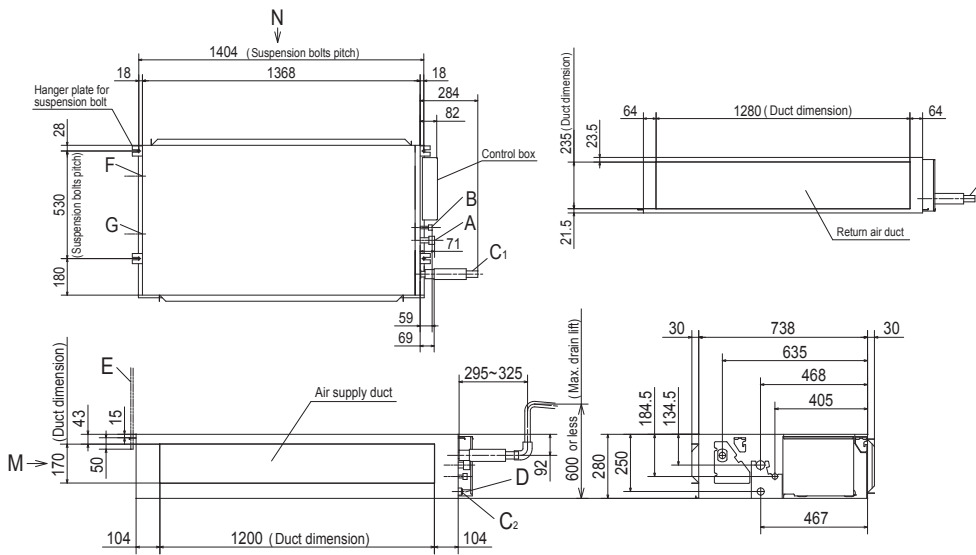

Symbol	Content	
A	Gas piping	φ 15.88 (5/8") (Flare)
B	Liquid piping	φ 9.52 (3/8") (Flare)
C1	Drain piping	VP25 (I.D.25,O.D.32)
C2	Drain piping (Gravity drainage)	VP20 (I.D.20,O.D.26)
D	Hole for wiring	
E	Suspension bolts	(M10)
F	Outside air opening for ducting	(Knock out)
G	Air outlet opening for ducting	(Knock out)
H	Inspection hole	(450X450)

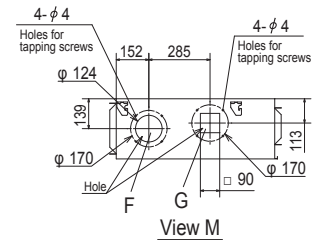

Models FDU200VG, 250VG

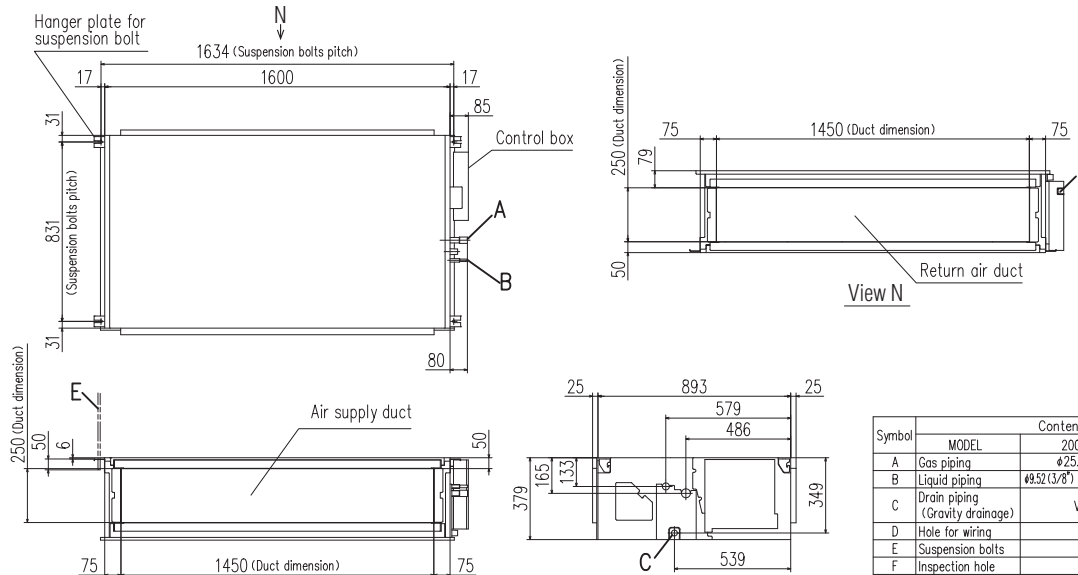

Symbol	Content		
	MODEL	200	250
A	Gas piping	φ25.4 (1") (Brazeing)	
B	Liquid piping	φ9.52 (3/8") (Brazeing)	φ12.7 (1/2") (Brazeing)
C	Drain piping (Gravity drainage)	VP25 (O.D.32)	
D	Hole for wiring		
E	Suspension bolts	M10	
F	Inspection hole	(450X450)	

SPECIFICATIONS

		<i>HyperInverter</i>			
Set model name		FDU71VNXVF1	FDU100VNXVF2	FDU125VNXVF	FDU140VNXVF
Indoor unit		FDU71VF1	FDU100VF2	FDU125VF	FDU140VF
Outdoor unit		FDC71VNX	FDC100VNX	FDC125VNX	FDC140VNX
Power source		1 Phase 220-240V, 50Hz / 220V, 60Hz			
Nominal cooling capacity (Min~Max)		kW 7.1 (3.2 ~ 8.0)	10.0 (4.0 ~ 11.2)	12.5 (5.0 ~ 14.0)	14.0 (5.0 ~ 16.0)
Nominal heating capacity (Min~Max)		kW 8.0 (3.6 ~ 9.0)	11.2 (4.0 ~ 12.5)	14.0 (4.0 ~ 17.0)	16.0 (4.0 ~ 18.0)
Power consumption	Cooling/Heating	kW 2.05 / 2.01	2.68 / 3.02	3.49 / 3.77	4.28 / 4.42
EER/COP	Cooling/Heating	3.46 / 3.98	3.73 / 3.71	3.58 / 3.71	3.27 / 3.62
Inrush current		A 5	5	5	5
Max. current		17	25	29	30
Sound power level*1	Indoor	Cooling/Heating	65 / 65	65 / 65	67 / 67
	Outdoor	Cooling/Heating	66 / 66	70 / 70	70 / 70
Sound pressure level*1	Indoor	Cooling (P-Hi/Hi/Me/Lo)	38 / 33 / 29 / 25	44 / 38 / 36 / 30	45 / 40 / 34 / 29
		Heating (P-Hi/Hi/Me/Lo)	38 / 33 / 29 / 25	44 / 38 / 36 / 30	45 / 40 / 34 / 29
	Outdoor	Cooling/Heating	51 / 48	48 / 50	48 / 50
		Cooling/Heating	51 / 48	48 / 50	48 / 50
Air flow	Indoor	Cooling (P-Hi/Hi/Me/Lo)	m ³ /min 24 / 19 / 15 / 10	36 / 28 / 25 / 19	39 / 32 / 26 / 20
		Heating (P-Hi/Hi/Me/Lo)	24 / 19 / 15 / 10	36 / 28 / 25 / 19	39 / 32 / 26 / 20
	Outdoor	Cooling/Heating	60 / 50	100 / 100	100 / 100
External static pressure*2		Pa Standard:35 Max:200	Standard:60 Max:200		
Exterior dimensions	Indoor	HeightxWidthxDepth	mm 280 x 950 x 635		
	Outdoor	HeightxWidthxDepth	750 x 880(+88) x 340		
Net weight	Indoor		kg 34		
	Outdoor		105		
Ref.piping size	Liquid/Gas	ømm	9.52(3/8") / 15.88(5/8")		
Refrigerant line (one way) length		m	Max.50	Max.100	
Vertical height differences		Outdoor is higher/lower	m Max.30 / Max.15		
Outdoor operating temperature range	Cooling	°C	-15~43*3		
	Heating		-20~20		
Air filter			Procure locally		
Remote control (option)			wired:RC-EX3A, RC-E5, RCH-E3 wireless:RCN-KIT4-E2		

		<i>HyperInverter</i>		
Set model name		FDU100VSXVF2	FDU125VSXVF	FDU140VSXVF
Indoor unit		FDU100VF2	FDU125VF	FDU140VF
Outdoor unit		FDC100VSX	FDC125VSX	FDC140VSX
Power source		3 Phase 380-415V, 50Hz / 380V, 60Hz		
Nominal cooling capacity (Min~Max)		kW 10.0 (4.0 ~ 11.2)	12.5 (5.0 ~ 14.0)	14.0 (5.0 ~ 16.0)
Nominal heating capacity (Min~Max)		kW 11.2 (4.0 ~ 16.0)	14.0 (4.0 ~ 18.0)	16.0 (4.0 ~ 20.0)
Power consumption	Cooling/Heating	kW 2.68 / 3.02	3.49 / 3.77	4.28 / 4.42
EER/COP	Cooling/Heating	3.73 / 3.71	3.58 / 3.71	3.27 / 3.62
Inrush current		A 5	5	5
Max. current		16	18	19
Sound power level*1	Indoor	Cooling/Heating	65 / 65	67 / 67
	Outdoor	Cooling/Heating	70 / 70	70 / 70
Sound pressure level*1	Indoor	Cooling (P-Hi/Hi/Me/Lo)	44 / 38 / 36 / 30	45 / 40 / 34 / 29
		Heating (P-Hi/Hi/Me/Lo)	44 / 38 / 36 / 30	45 / 40 / 34 / 29
	Outdoor	Cooling/Heating	48 / 50	48 / 50
		Cooling/Heating	48 / 50	48 / 50
Air flow	Indoor	Cooling (P-Hi/Hi/Me/Lo)	m ³ /min 36 / 28 / 25 / 19	39 / 32 / 26 / 20
		Heating (P-Hi/Hi/Me/Lo)	36 / 28 / 25 / 19	39 / 32 / 26 / 20
	Outdoor	Cooling/Heating	100 / 100	100 / 100
External static pressure*2		Pa Standard:60 Max:200	Standard:60 Max:200	
Exterior dimensions	Indoor	HeightxWidthxDepth	mm 280 x 1,370 x 740	
	Outdoor	HeightxWidthxDepth	1,300 x 970 x 370	
Net weight	Indoor		kg 54	
	Outdoor		105	
Ref.piping size	Liquid/Gas	ømm	9.52(3/8") / 15.88(5/8")	
Refrigerant line (one way) length		m	Max.100	
Vertical height differences		Outdoor is higher/lower	m Max.30 / Max.15	
Outdoor operating temperature range	Cooling	°C	-15~43*3	
	Heating		-20~20	
Air filter			Procure locally	
Remote control (option)			wired:RC-EX3A, RC-E5, RCH-E3 wireless:RCN-KIT4-E2	

NOTES:

The data are measured under the following conditions(ISO-T1).

Cooling:Indoor temp. of 27°CDB, 19°CWB, and outdoor temp. of 35°CDB. Heating:Indoor temp. of 20°CDB, and outdoor temp. of 7°CDB, 6°CWB.

*1 : Indicates the value in an anechoic chamber. During operation these values are somewhat higher due to ambient conditions.

*2 : External static pressure is changeable to be set by the remote control. MAX external static pressure is "High static pressure" setting. The values of sound pressure level become 5dB(A) higher at external static pressure of 200Pa.

*3 : If a cooling operation is conducted when the outdoor air temperature is -5°C or lower, the outdoor unit should be installed at a place where it is not influenced by natural wind. If wind blows, the low pressure will drop and compressor frequency will increase, this will cause the capacity to drop and may cause the unit to break down.

SPECIFICATIONS

		Micro Inverter							
Set model name		FDU100VNAVF2	FDU125VNAVF	FDU140VNAVF	FDU100VSAVF2	FDU125VSAVF	FDU140VSAVF		
Indoor unit		FDU100VF2	FDU125VF	FDU140VF	FDU100VF2	FDU125VF	FDU140VF		
Outdoor unit		FDC100VNA	FDC125VNA	FDC140VNA	FDC100VSA	FDC125VSA	FDC140VSA		
Power source		1 Phase 220-240V, 50Hz / 220V, 60Hz			3 Phase 380-415V, 50Hz / 380V, 60Hz				
Nominal cooling capacity (Min~Max)		kW 10.0 (4.0 ~ 11.2)	12.5 (5.0 ~ 14.0)	13.6 (5.0 ~ 14.5)	10.0 (4.0 ~ 11.2)	12.5 (5.0 ~ 14.0)	13.6 (5.0 ~ 14.5)		
Nominal heating capacity (Min~Max)		kW 11.2 (4.0 ~ 12.5)	14.0 (4.0 ~ 16.0)	15.5 (4.0 ~ 16.5)	11.2 (4.0 ~ 12.5)	14.0 (4.0 ~ 16.0)	15.5 (4.0 ~ 16.5)		
Power consumption		2.84 / 2.78	4.36 / 3.69	4.93 / 4.21	2.84 / 2.78	4.36 / 3.69	4.93 / 4.21		
EER/COP		3.52 / 4.03	2.87 / 3.79	2.76 / 3.68	3.52 / 4.03	2.87 / 3.79	2.76 / 3.68		
Inrush current		5	5	5	5	5	5		
Max. current		A 26	26	27	17	17	18		
Sound power level*1	Indoor	65 / 65	67 / 67	70 / 70	65 / 65	67 / 67	70 / 70		
	Outdoor	70 / 70	71 / 71	73 / 73	70 / 70	71 / 71	73 / 73		
Sound pressure level*1	Indoor	Cooling (P-Hi/Hi/Me/Lo)	44 / 38 / 36 / 30	45 / 40 / 34 / 29	47 / 40 / 35 / 30	44 / 38 / 36 / 30	45 / 40 / 34 / 29	47 / 40 / 35 / 30	
		Heating (P-Hi/Hi/Me/Lo)	44 / 38 / 36 / 30	45 / 40 / 34 / 29	47 / 40 / 35 / 30	44 / 38 / 36 / 30	45 / 40 / 34 / 29	47 / 40 / 35 / 30	
	Outdoor	Cooling/Heating	54 / 56	55 / 57	57 / 59	54 / 56	55 / 57	57 / 59	
		Air flow	Indoor	Cooling (P-Hi/Hi/Me/Lo)	36 / 28 / 25 / 19	39 / 32 / 26 / 20	48 / 35 / 28 / 22	36 / 28 / 25 / 19	39 / 32 / 26 / 20
		Heating (P-Hi/Hi/Me/Lo)	36 / 28 / 25 / 19	39 / 32 / 26 / 20	48 / 35 / 28 / 22	36 / 28 / 25 / 19	39 / 32 / 26 / 20	48 / 35 / 28 / 22	
		Outdoor	Cooling/Heating	75 / 73	75 / 73	75 / 73	75 / 73	75 / 73	75 / 73
External static pressure*2		Pa	Standard:60 Max:200						
Exterior dimensions	Indoor	HeightxWidthxDPTH	280 x 1,370 x 740						
	Outdoor		845 x 970 x 370						
Net weight	Indoor	kg	54						
	Outdoor		80		82				
Ref.piping size	Liquid/Gas	ømm	9.52(3/8") / 15.88(5/8")						
Refrigerant line (one way) length		m	Max.50						
Vertical height differences		Outdoor is higher/lower	Max.50 / Max.15						
Outdoor operating temperature range	Cooling	°C	-15~50*3						
	Heating		-20~20						
Air filter			Procure locally						
Remote control (option)			wired:RC-EX3A, RC-E5, RCH-E3 wireless:RCN-KIT4-E2						

		Micro Inverter		Standard Inverter				
Set model name		FDU200VSAVG	FDU250VSAVG	FDU71VNPVF1	FDU90VNP1VF2	FDU100VNP1VF2		
Indoor unit		FDU200VG	FDU250VG	FDU71VF1	FDU100VF2	FDU100VF2		
Outdoor unit		FDC200VSA	FDC250VSA	FDC71VNP	FDC90VNP1	FDC100VNP		
Power source		3 Phase 380-415V, 50Hz / 380V, 60Hz		1 Phase 220-240V, 50Hz / 220V, 60Hz				
Nominal cooling capacity (Min~Max)		kW 19.0 (5.2 ~ 22.4)	24.0 (6.9 ~ 28.0)	7.1 (1.4 ~ 7.1)	9.0 (1.9 ~ 9.0)	10.0 (2.8 ~ 11.2)		
Nominal heating capacity (Min~Max)		kW 22.4 (3.3 ~ 25.0)	27.0 (5.5 ~ 31.5)	7.1 (1.0 ~ 7.1)	9.0 (1.5 ~ 9.0)	11.2 (2.5 ~ 12.5)		
Power consumption		6.15 / 6.03	7.98 / 7.20	2.60 / 1.89	2.69 / 2.25	3.00 / 2.93		
EER/COP		3.09 / 3.71	3.01 / 3.75	2.73 / 3.76	3.35 / 4.00	3.33 / 3.82		
Inrush current		5	5	5	5	5		
Max. current		A 25	27	14.5	18.0	22.0		
Sound power level*1	Indoor	75 / 75	75 / 75	65 / 65	65 / 65	65 / 65		
	Outdoor	72 / 74	73 / 75	67 / 67	69 / 69	70 / 70		
Sound pressure level*1	Indoor	Cooling (P-Hi/Hi/Me/Lo)	52 / 50 / 47 / 45	52 / 50 / 47 / 45	38 / 33 / 29 / 25	44 / 38 / 36 / 30	44 / 38 / 36 / 30	
		Heating (P-Hi/Hi/Me/Lo)	52 / 50 / 47 / 45	52 / 50 / 47 / 45	38 / 33 / 29 / 25	44 / 38 / 36 / 30	44 / 38 / 36 / 30	
	Outdoor	Cooling/Heating	57 / 59	59 / 62	54 / 54	57 / 55	57 / 61	
		Air flow	Indoor	Cooling (P-Hi/Hi/Me/Lo)	80 / 72 / 64 / 56	80 / 72 / 64 / 56	24 / 19 / 15 / 10	36 / 28 / 25 / 19
		Heating (P-Hi/Hi/Me/Lo)	80 / 72 / 64 / 56	80 / 72 / 64 / 56	24 / 19 / 15 / 10	36 / 28 / 25 / 19	36 / 28 / 25 / 19	
		Outdoor	Cooling/Heating	135 / 135	143 / 151	36 / 36	63 / 49.5	75 / 79
External static pressure*2		Pa	Standard:72 Max:200	Standard:35 Max:200	Standard:60 Max:200			
Exterior dimensions	Indoor	HeightxWidthxDPTH	379 x 1,600 x 893		280 x 950 x 635			
	Outdoor		1,300 x 970 x 370	1,505 x 970 x 370	640 x 800(+71) x 290	750 x 880(+88) x 340	845 x 970 x 370	
Net weight	Indoor	kg	89		34			
	Outdoor		115	143	45	57	70	
Ref.piping size	Liquid/Gas	ømm	9.52(3/8") / 22.22(7/8")	12.7(1/2") / 25.4(1")	6.35(1/4") / 12.7(1/2")	6.35(1/4") / 15.88(5/8")	9.52(3/8") / 15.88(5/8")	
Refrigerant line (one way) length		m	Max.70		Max.30			
Vertical height differences		Outdoor is higher/lower	Max.30 / Max.15		Max.20 / Max.20			
Outdoor operating temperature range	Cooling	°C	-15~50*3		-15~46*3			
	Heating		-15~20		-15~20			
Air filter			Procure locally		Procure locally			
Remote control (option)			wired:RC-EX3A, RC-E5, RCH-E3 wireless:RCN-KIT4-E2		wired:RC-EX3A, RC-E5, RCH-E3 wireless:RCN-KIT4-E2			

NOTES:

The data are measured under the following conditions(ISO-T1).

Cooling:Indoor temp. of 27°CDB, 19°CWB, and outdoor temp. of 35°CDB. Heating:Indoor temp. of 20°CDB, and outdoor temp. of 7°CDB, 6°CWB.

*1 : Indicates the value in an anechoic chamber. During operation these values are somewhat higher due to ambient conditions.

*2 : External static pressure is changeable to be set by the remote control. MAX external static pressure is "High static pressure" setting. The values of sound pressure level become 5dB(A) higher at external static pressure of 200Pa.

*3 : If a cooling operation is conducted when the outdoor air temperature is -5°C or lower, the outdoor unit should be installed at a place where it is not influenced by natural wind. If wind blows, the low pressure will drop and compressor frequency will increase, this will cause the capacity to drop and may cause the unit to break down.

DUCT CONNECTED -Low/Middle Static pressure- FDUM



FDUM 40/50/60/71/100/125/140

Remote control (option)

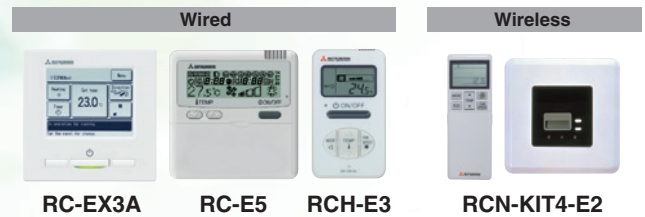

Filter kit (option)



UM-FL1EF : for 40, 50
 UM-FL2EF : for 60, 71
 UM-FL3EF : for 100, 125, 140
 external static pressure loss:5Pa



*Not all functions are available with all remote control options.

Point 1 Thin design

The height of all FDUM models is only 280mm.

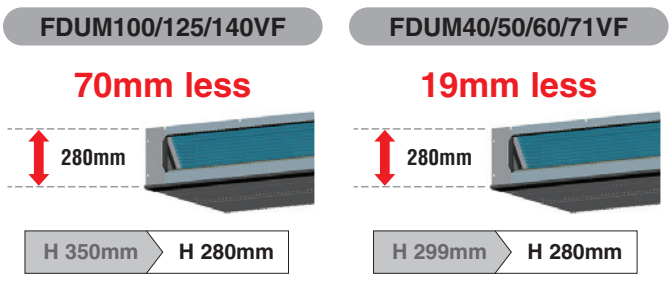

Point 2 Improvement of the serviceability

Fan unit (impeller and motor) can be pulled out from the right side of the unit. Maintenance can be available from the right side or the bottom side.

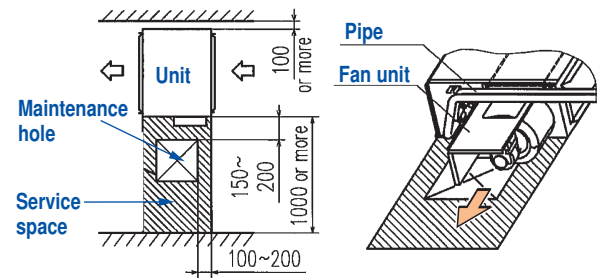

Point 3 Automatic external static pressure (E.S.P.) control

You can set External Static Pressure (E.S.P.) by method of manual setting on remote control. Indoor unit will control fan-speed to keep rated air flow volume at each fan speed setting. You can set required E.S.P. by wired remote control that calculated with the set air flow rate and pressure loss of the duct connected.

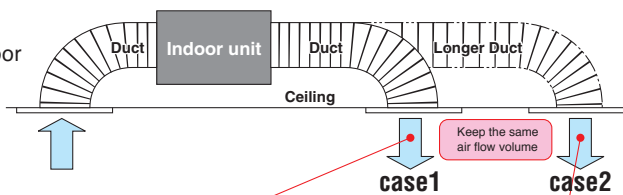

Expansion of external static pressure range

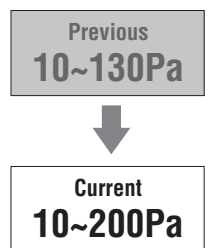

RC-E5 E.S.P. button
 External Static Pressure (E.S.P.) can be set by E.S.P. button.



Setting No.	No.8	No.9	No.10	No.11	No.12	No.13	No.14	No.15
E.S.P.	80Pa	90Pa	100Pa	110Pa	120Pa	130Pa	140Pa	150Pa

* Range of 80~150 Pa is set at ex-factory default.
 Range of 10~200 Pa is available by setting SW8-4 switch on at site.

Point
4

Transparent inspection window

Dirt condition of the bottom of a drain pan can be checked through this transparent inspection window without removing drain pan. (Please refer to P39)

Point
5

Enhanced installation workability

600mm Drain Pump is mounted in all models.
The indoor unit is completely hidden in the ceiling, so this is suitable for spaces with classy interior decoration.

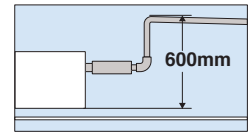

Round duct adapter



Company: AIRZONE
URL: <http://www.airzone.es>

All-in-one solution: the whole zoning system in a plug&play device perfectly adapted to the indoor DX unit

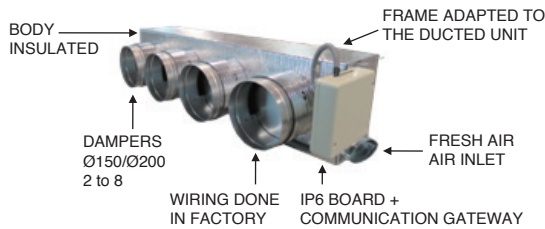

Main components

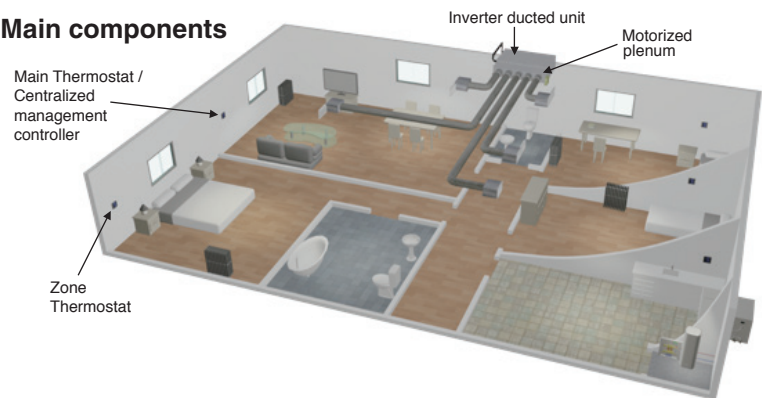

OUTDOOR UNIT

SRC • FDC	Hyper Inverter			Micro Inverter		
	40~60ZSX	71VNX	100~140VN(S)X	100~140VN(S)A	200VSA	250VSA
model						
Chargeless	15m	30m		30m		
Height x Width x Depth (mm)	640 x 800(+71) x 290	750 x 880(+88) x 340	1,300 x 970 x 370	845 x 970 x 370	1,300 x 970 x 370	1,505 x 970 x 370

FDC	Standard Inverter		
	71VNP	90VNP1	100VNP
model			
Chargeless	15m		
Height x Width x Depth (mm)	640 x 800(+71) x 290	750 x 880(+88) x 340	845 x 970 x 370

DIMENSIONS (Unit:mm)

Models FDUM40VF, FDUM50VF

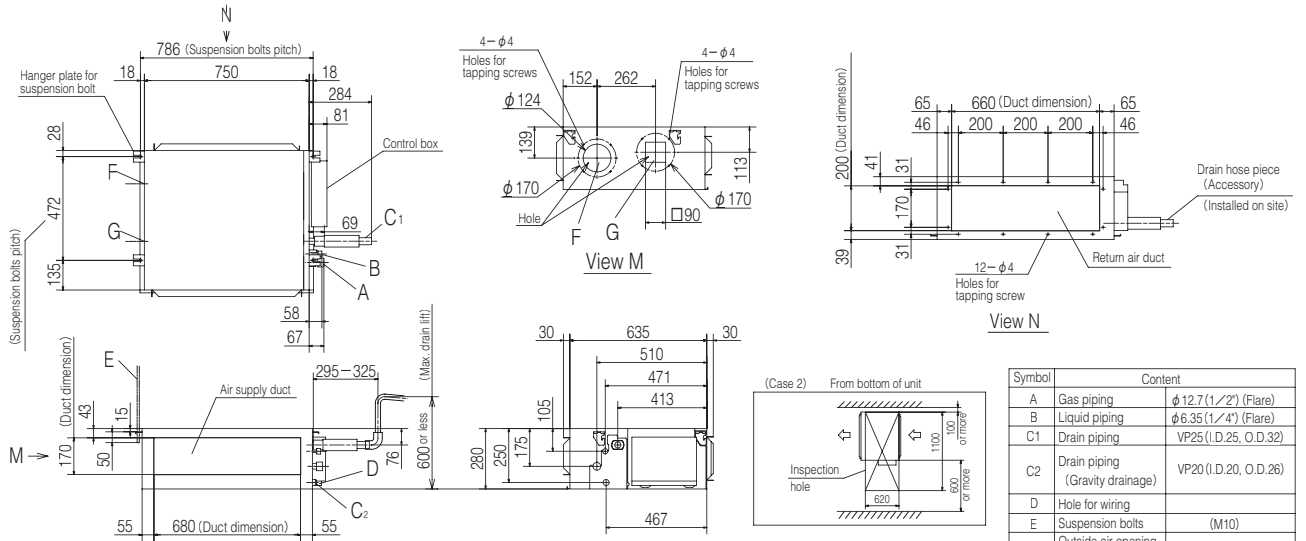

Models FDUM60VF,71VF1

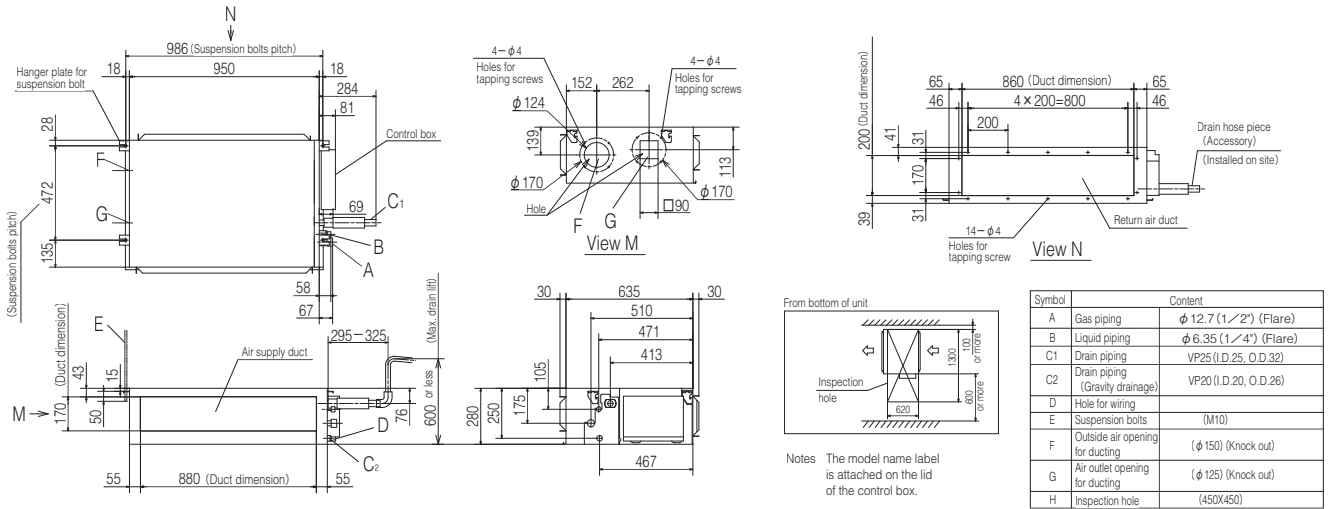

Models FDUM100VF2,125VF,140VF

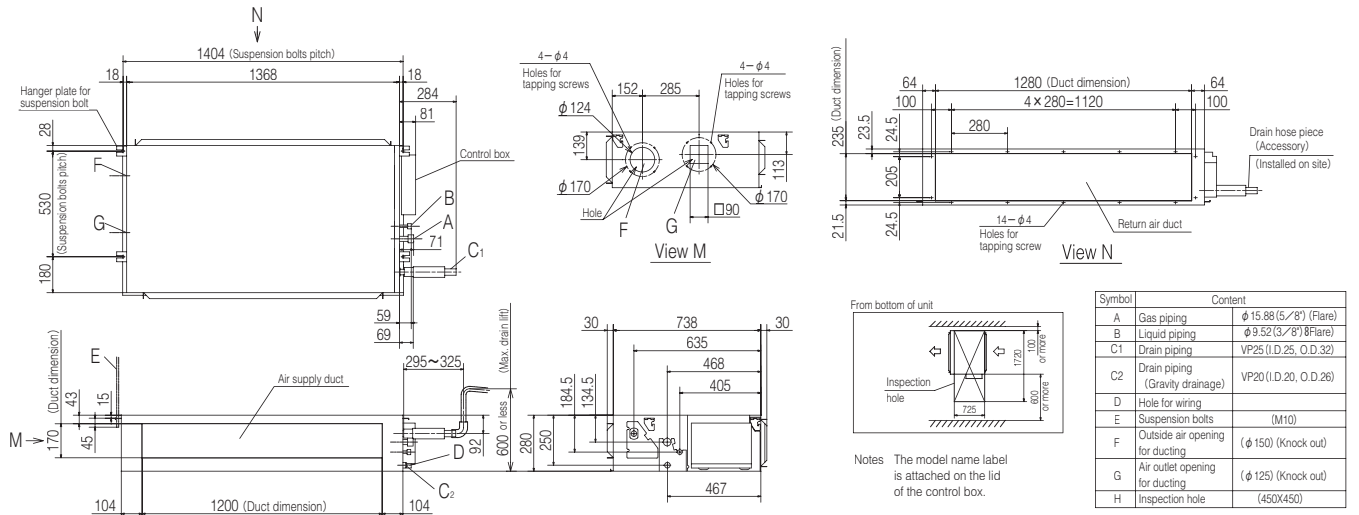

SPECIFICATIONS

			<i>HyperInverter</i>				
Set model name			FDUM40ZSXVF	FDUM50ZSXVF	FDUM60ZSXVF	FDUM71VNXVF1	FDUM100VNXVF2
Indoor unit			FDUM40VF	FDUM50VF	FDUM60VF	FDUM71VF1	FDUM100VF2
Outdoor unit			SRC40ZSX-S	SRC50ZSX-S	SRC60ZSX-S	FDC71VNX	FDC100VNX
Power source			1 Phase 220-240V, 50Hz / 220V, 60Hz				
Nominal cooling capacity (Min~Max)			kW 4.0 (1.1 ~ 4.7)	5.0 (1.1 ~ 5.6)	5.6 (1.1 ~ 6.3)	7.1 (3.2 ~ 8.0)	10.0 (4.0 ~ 11.2)
Nominal heating capacity (Min~Max)			kW 4.5 (0.6 ~ 5.4)	5.4 (0.6 ~ 6.3)	6.7 (0.6 ~ 7.1)	8.0 (3.6 ~ 9.0)	11.2 (4.0 ~ 12.5)
Power consumption			Cooling/Heating kW 0.952 / 1.07	1.38 / 1.45	1.54 / 1.75	2.03 / 1.99	2.68 / 3.02
EER/COP			Cooling/Heating 4.20 / 4.21	3.62 / 3.72	3.64 / 3.83	3.50 / 4.02	3.73 / 3.71
Inrush current			A				
Max. current			5	5	5	5	5
Sound power level*1			12	15	15	17	24
Sound power level*1	Indoor	Cooling/Heating	60 / 60	60 / 60	60 / 60	65 / 65	65 / 65
	Outdoor	Cooling/Heating	63 / 63	63 / 63	65 / 64	66 / 66	70 / 70
Sound pressure level*1	Indoor	Cooling (P-Hi/Hi/Me/Lo)	dB(A) 37 / 32 / 29 / 26	37 / 32 / 29 / 26	36 / 31 / 28 / 25	38 / 33 / 29 / 25	44 / 38 / 36 / 30
		Heating (P-Hi/Hi/Me/Lo)	37 / 32 / 29 / 26	37 / 32 / 29 / 26	36 / 31 / 28 / 25	38 / 33 / 29 / 25	44 / 38 / 36 / 30
	Outdoor	Cooling/Heating	50 / 49	50 / 49	52 / 52	51 / 48	48 / 50
		Cooling (P-Hi/Hi/Me/Lo)	m³/min 13 / 10 / 9 / 8	13 / 10 / 9 / 8	20 / 15 / 13 / 10	24 / 19 / 15 / 10	36 / 28 / 25 / 19
Air flow	Indoor	Heating (P-Hi/Hi/Me/Lo)	13 / 10 / 9 / 8	13 / 10 / 9 / 8	20 / 15 / 13 / 10	24 / 19 / 15 / 10	36 / 28 / 25 / 19
		Outdoor	Cooling/Heating	36 / 33	40 / 33	41.5 / 39	60 / 50
External static pressure*3			Pa Standard:35 Max:100				
Exterior dimensions	Indoor	HeightxWidthxDepth	mm 280 x 750 x 635		280 x 950 x 635		280 x 1,370 x 740
			640 x 800(+71) x 290		750 x 880(+88) x 340		1,300 x 970 x 370
Net weight	Indoor		kg 29		34		54
			45		60		105
Ref.piping size	Liquid/Gas	ømm	6.35(1/4") / 12.7(1/2")			9.52(3/8") / 15.88(5/8")	
Refrigerant line (one way) length			m Max.30			Max.50 Max.100	
Vertical height differences			Outdoor is higher/lower m Max.20 / Max.20			Max.30 / Max.15	
Outdoor operating temperature range	Cooling	°C	-15~46*4			-15~43*4	
			Heating	-20~24			-20~20
Air filter				Filter kit : UM-FL1EF / UM-FL2EF / UM-FL3EF (option)			
Remote control (option)			wired:RC-EX3A, RC-E5, RCH-E3 wireless:RCN-KIT4-E2				

			<i>HyperInverter</i>				
Set model name			FDUM125VNXVF	FDUM140VNXVF	FDUM100VSXVF2	FDUM125VSXVF	FDUM140VSXVF
Indoor unit			FDUM125VF	FDUM140VF	FDUM100VF2	FDUM125VF	FDUM140VF
Outdoor unit			FDC125VNX	FDC140VNX	FDC100VSX	FDC125VSX	FDC140VSX
Power source			1 Phase 220-240V, 50Hz / 220V, 60Hz			3 Phase 380-415V, 50Hz / 380V, 60Hz	
Nominal cooling capacity (Min~Max)			kW 12.5 (5.0 ~ 14.0)	14.0 (5.0 ~ 16.0)	10.0 (4.0 ~ 11.2)	12.5 (5.0 ~ 14.0)	14.0 (5.0 ~ 16.0)
Nominal heating capacity (Min~Max)			kW 14.0 (4.0 ~ 17.0)	16.0 (4.0 ~ 18.0)	11.2 (4.0 ~ 16.0)	14.0 (4.0 ~ 18.0)	16.0 (4.0 ~ 20.0)
Power consumption			Cooling/Heating kW 3.49 / 3.77	4.28 / 4.42	2.68 / 3.02	3.49 / 3.77	4.28 / 4.42
EER/COP			Cooling/Heating 3.58 / 3.71	3.27 / 3.62	3.73 / 3.71	3.58 / 3.71	3.27 / 3.62
Inrush current			A				
Max. current			5	5	5	5	5
Sound power level*1			26	26	15	15	15
Sound power level*1	Indoor	Cooling/Heating	67 / 67	70 / 70	65 / 65	67 / 67	70 / 70
	Outdoor	Cooling/Heating	70 / 70	72 / 72	70 / 70	70 / 70	72 / 72
Sound pressure level*1	Indoor	Cooling (P-Hi/Hi/Me/Lo)	dB(A) 45 / 40 / 34 / 29	47 / 40 / 35 / 30	44 / 38 / 36 / 30	45 / 40 / 34 / 29	47 / 40 / 35 / 30
		Heating (P-Hi/Hi/Me/Lo)	45 / 40 / 34 / 29	47 / 40 / 35 / 30	44 / 38 / 36 / 30	45 / 40 / 34 / 29	47 / 40 / 35 / 30
	Outdoor	Cooling/Heating	48 / 50	49 / 52	48 / 50	48 / 50	49 / 52
		Cooling (P-Hi/Hi/Me/Lo)	m³/min 39 / 32 / 26 / 20	48 / 35 / 28 / 22	36 / 28 / 25 / 19	39 / 32 / 26 / 20	48 / 35 / 28 / 22
Air flow	Indoor	Heating (P-Hi/Hi/Me/Lo)	39 / 32 / 26 / 20	48 / 35 / 28 / 22	36 / 28 / 25 / 19	39 / 32 / 26 / 20	48 / 35 / 28 / 22
		Outdoor	Cooling/Heating	100 / 100	100 / 100	100 / 100	100 / 100
External static pressure*3			Pa Standard:60 Max:100				
Exterior dimensions	Indoor	HeightxWidthxDepth	mm 280 x 1,370 x 740		1,300 x 970 x 370		
			54		105		
Net weight	Indoor		kg 54		105		
			105				
Ref.piping size	Liquid/Gas	ømm	9.52(3/8") / 15.88(5/8")				
Refrigerant line (one way) length			m Max.100				
Vertical height differences			Outdoor is higher/lower m Max.30 / Max.15				
Outdoor operating temperature range	Cooling	°C	-15~43*4				
			Heating	-20~20			
Air filter				Filter kit : UM-FL3EF (option)			
Remote control (option)			wired:RC-EX3A, RC-E5, RCH-E3 wireless:RCN-KIT4-E2				

NOTES:

- The data are measured under the following conditions(ISO-T1).
Cooling:Indoor temp. of 27°CDB, 19°CWB, and outdoor temp. of 35°CDB. Heating:Indoor temp. of 20°CDB, and outdoor temp. of 7°CDB, 6°CWB.
- *1 : Indicates the value in an anechoic chamber. During operation these values are somewhat higher due to ambient conditions.
 - *2 : The values are for one indoor unit operation. (Multi system only)
 - *3 : External static pressure is changeable to be set by the remote control. MAX external static pressure is "High static pressure" setting. The values of sound pressure level become 5dB(A) higher at external static pressure of 100Pa.
 - *4 : If a cooling operation is conducted when the outdoor air temperature is -5°C or lower, the outdoor unit should be installed at a place where it is not influenced by natural wind. If wind blows, the low pressure will drop and compressor frequency will increase, this will cause the capacity to drop and may cause the unit to break down.

SPECIFICATIONS

The values are for simultaneous Multi operation.

Set model name		Hyper Inverter				
		FDUM71VNXPVF	FDUM100VNXPVF	FDUM125VNXPVF	FDUM140VNXPVF1	FDUM140VNXTVF
		Twin			Triple	
Indoor unit		FDUM40VF x 2	FDUM50VF x 2	FDUM60VF x 2	FDUM71VF1 x 2	FDUM50VF x 3
Outdoor unit		FDC71VNX	FDC100VNX	FDC125VNX	FDC140VNX	FDC140VNX
Power source		1 Phase 220-240V, 50Hz / 220V, 60Hz				
Nominal cooling capacity (Min-Max)	kW	7.1 (3.2 ~ 8.0)	10.0 (4.0 ~ 11.2)	12.5 (5.0 ~ 14.0)	14.0 (5.0 ~ 16.0)	14.0 (5.0 ~ 16.0)
Nominal heating capacity (Min-Max)	kW	8.0 (3.6 ~ 9.0)	11.2 (4.0 ~ 12.5)	14.0 (4.0 ~ 17.0)	16.0 (4.0 ~ 18.0)	16.0 (4.0 ~ 18.0)
Power consumption	Cooling/Heating kW	2.01 / 1.91	2.66 / 3.02	3.26 / 3.66	4.36 / 4.35	4.21 / 4.69
EER/COP	Cooling/Heating	3.53 / 4.19	3.76 / 3.71	3.83 / 3.83	3.21 / 3.68	3.33 / 3.41
Inrush current	A	5	5	5	5	5
Max. current		17	24	26	26	26
Sound power level*1	Indoor*2	Cooling/Heating	60 / 60	60 / 60	60 / 60	65 / 65
	Outdoor	Cooling/Heating	66 / 66	70 / 70	70 / 70	72 / 72
Sound pressure level*1	Indoor*2	Cooling (P-Hi/Hi/Me/Lo)	37 / 32 / 29 / 26	37 / 32 / 29 / 26	36 / 31 / 28 / 25	38 / 33 / 29 / 25
		Heating (P-Hi/Hi/Me/Lo)	37 / 32 / 29 / 26	37 / 32 / 29 / 26	36 / 31 / 28 / 25	38 / 33 / 29 / 25
	Outdoor	Cooling/Heating	51 / 48	48 / 50	48 / 50	49 / 52
		Cooling/Heating	13 / 10 / 9 / 8	13 / 10 / 9 / 8	20 / 15 / 13 / 10	24 / 19 / 15 / 10
Air flow	Indoor*2	Cooling (P-Hi/Hi/Me/Lo)	13 / 10 / 9 / 8	13 / 10 / 9 / 8	20 / 15 / 13 / 10	24 / 19 / 15 / 10
		Heating (P-Hi/Hi/Me/Lo)	13 / 10 / 9 / 8	13 / 10 / 9 / 8	20 / 15 / 13 / 10	24 / 19 / 15 / 10
	Outdoor	Cooling/Heating	60 / 50	100 / 100	100 / 100	100 / 100
External static pressure*3	Pa	Standard:35 Max:100				
Exterior dimensions	Indoor	280 x 750 x 635			280 x 950 x 635	
	Outdoor	750 x 880(+88) x 340			1,300 x 970 x 370	
Net weight	Indoor	29			34	
	Outdoor	60			105	
Ref.piping size	Liquid/Gas	ømm 9.52(3/8") / 15.88(5/8")				
Refrigerant line (one way) length	m	Max.50			Max.100	
Vertical height differences	Outdoor is higher/lower	m Max.30 / Max.15				
Outdoor operating temperature range	Cooling	°C -15~43**4				
	Heating	°C -20~20				
Air filter		Filter kit : UM-FL1EF / UM-FL2EF (option)				
Remote control (option)		wired:RC-EX3A, RC-E5, RCH-E3 wireless:RCN-KIT4-E2				

The values are for simultaneous Multi operation.

Set model name		Hyper Inverter				
		FDUM100VVSXPVF	FDUM125VVSXPVF	FDUM140VVSXPVF1	FDUM140VVSXTVF	
		Twin		Triple		
Indoor unit		FDUM50VF x 2	FDUM60VF x 2	FDUM71VF1 x 2	FDUM50VF x 3	
Outdoor unit		FDC100VVSX	FDC125VVSX	FDC140VVSX	FDC140VVSX	
Power source		3 Phase 380-415V, 50Hz / 380V, 60Hz				
Nominal cooling capacity (Min-Max)	kW	10.0 (4.0 ~ 11.2)	12.5 (5.0 ~ 14.0)	14.0 (5.0 ~ 16.0)	14.0 (5.0 ~ 16.0)	
Nominal heating capacity (Min-Max)	kW	11.2 (4.0 ~ 16.0)	14.0 (4.0 ~ 18.0)	16.0 (4.0 ~ 20.0)	16.0 (4.0 ~ 20.0)	
Power consumption	Cooling/Heating kW	2.66 / 3.02	3.26 / 3.66	4.36 / 4.35	4.21 / 4.69	
EER/COP	Cooling/Heating	3.76 / 3.71	3.83 / 3.83	3.21 / 3.68	3.33 / 3.41	
Inrush current	A	5	5	5	5	
Max. current		15	15	15	15	
Sound power level*1	Indoor*2	Cooling/Heating	60 / 60	60 / 60	65 / 65	
	Outdoor	Cooling/Heating	70 / 70	70 / 70	72 / 72	
Sound pressure level*1	Indoor*2	Cooling (P-Hi/Hi/Me/Lo)	37 / 32 / 29 / 26	36 / 31 / 28 / 25	38 / 33 / 29 / 25	
		Heating (P-Hi/Hi/Me/Lo)	37 / 32 / 29 / 26	36 / 31 / 28 / 25	38 / 33 / 29 / 25	
	Outdoor	Cooling/Heating	48 / 50	48 / 50	49 / 52	
		Cooling/Heating	13 / 10 / 9 / 8	20 / 15 / 13 / 10	24 / 19 / 15 / 10	
Air flow	Indoor*2	Cooling (P-Hi/Hi/Me/Lo)	13 / 10 / 9 / 8	20 / 15 / 13 / 10	24 / 19 / 15 / 10	
		Heating (P-Hi/Hi/Me/Lo)	13 / 10 / 9 / 8	20 / 15 / 13 / 10	24 / 19 / 15 / 10	
	Outdoor	Cooling/Heating	100 / 100	100 / 100	100 / 100	
External static pressure*3	Pa	Standard:35 Max:100				
Exterior dimensions	Indoor	280 x 750 x 635			280 x 950 x 635	
	Outdoor				1,300 x 970 x 370	
Net weight	Indoor	29			34	
	Outdoor				105	
Ref.piping size	Liquid/Gas	ømm 9.52(3/8") / 15.88(5/8")				
Refrigerant line (one way) length	m	Max.100				
Vertical height differences	Outdoor is higher/lower	m Max.30 / Max.15				
Outdoor operating temperature range	Cooling	°C -15~43**4				
	Heating	°C -20~20				
Air filter		Filter kit : UM-FL1EF / UM-FL2EF (option)				
Remote control (option)		wired:RC-EX3A, RC-E5, RCH-E3 wireless:RCN-KIT4-E2				

SPECIFICATIONS

			Micro Inverter						
Set model name			FDUM100VNAV2	FDUM125VNAV	FDUM140VNAV	FDUM100VSAV2	FDUM125VSAV	FDUM140VSAV	
Indoor unit			FDUM100VF2	FDUM125VF	FDUM140VF	FDUM100VF2	FDUM125VF	FDUM140VF	
Outdoor unit			FDC100VNA	FDC125VNA	FDC140VNA	FDC100VSA	FDC125VSA	FDC140VSA	
Power source			1 Phase 220-240V, 50Hz / 220V, 60Hz			3 Phase 380-415V, 50Hz / 380V, 60Hz			
Nominal cooling capacity (Min~Max)			kW	10.0 (4.0 ~ 11.2)	12.5 (5.0 ~ 14.0)	13.6 (5.0 ~ 14.5)	10.0 (4.0 ~ 11.2)	12.5 (5.0 ~ 14.0)	13.6 (5.0 ~ 14.5)
Nominal heating capacity (Min~Max)			kW	11.2 (4.0 ~ 12.5)	14.0 (4.0 ~ 16.0)	15.5 (4.0 ~ 16.5)	11.2 (4.0 ~ 12.5)	14.0 (4.0 ~ 16.0)	15.5 (4.0 ~ 16.5)
Power consumption			kW	2.84 / 2.78	4.36 / 3.69	4.93 / 4.21	2.84 / 2.78	4.36 / 3.69	4.93 / 4.21
EER/COP				3.52 / 4.03	2.87 / 3.79	2.76 / 3.68	3.52 / 4.03	2.87 / 3.79	2.76 / 3.68
Inrush current			A	5	5	5	5	5	5
Max. current				26	26	27	17	17	18
Sound power level*1	Indoor	Cooling/Heating	dB(A)	65 / 65	67 / 67	70 / 70	65 / 65	67 / 67	70 / 70
	Outdoor	Cooling/Heating		70 / 70	71 / 71	73 / 73	70 / 70	71 / 71	73 / 73
Sound pressure level*1	Indoor	Cooling (P-Hi/Hi/Me/Lo)		44 / 38 / 36 / 30	45 / 40 / 34 / 29	47 / 40 / 35 / 30	44 / 38 / 36 / 30	45 / 40 / 34 / 29	47 / 40 / 35 / 30
		Heating (P-Hi/Hi/Me/Lo)		44 / 38 / 36 / 30	45 / 40 / 34 / 29	47 / 40 / 35 / 30	44 / 38 / 36 / 30	45 / 40 / 34 / 29	47 / 40 / 35 / 30
	Outdoor	Cooling/Heating		54 / 56	55 / 57	57 / 59	54 / 56	55 / 57	57 / 59
		Air flow		Cooling (P-Hi/Hi/Me/Lo)	36 / 28 / 25 / 19	39 / 32 / 26 / 20	48 / 35 / 28 / 22	36 / 28 / 25 / 19	39 / 32 / 26 / 20
	Heating (P-Hi/Hi/Me/Lo)	36 / 28 / 25 / 19	39 / 32 / 26 / 20	48 / 35 / 28 / 22	36 / 28 / 25 / 19	39 / 32 / 26 / 20	48 / 35 / 28 / 22		
	Outdoor	Cooling/Heating	75 / 73	75 / 73	75 / 73	75 / 73	75 / 73	75 / 73	
External static pressure*3			Pa	Standard:60 Max:100					
Exterior dimensions	Indoor	HeightxWidthxDepth	mm	280 x 1,370 x 740					
	Outdoor			845 x 970 x 370					
Net weight	Indoor		kg	54					
	Outdoor			80					82
Ref.piping size			Liquid/Gas	ømm					
Refrigerant line (one way) length			m	9.52(3/8") / 15.88(5/8")					
Vertical height differences			Outdoor is higher/lower	Max.50					
Outdoor operating temperature range	Cooling	°C	Max.50 / Max.15						
	Heating		-15~50*4						
Air filter			-20~20						
Remote control (option)			Filter kit : UM-FL3EF (option) wired:RC-EX3A, RC-E5, RCH-E3 wireless:RCN-KIT4-E2						

The values are for simultaneous Multi operation.

			Micro Inverter						
Set model name			FDUM100VNAPVF	FDUM125VNAPVF	FDUM140VNAPVF1	FDUM140VNATVF	FDUM100VSAPVF		
			Twin		Triple	Twin			
Indoor unit			FDUM50VF x 2	FDUM60VF x 2	FDUM71VF1 x 2	FDUM50VF x 3	FDUM50VF x 2		
Outdoor unit			FDC100VNA	FDC125VNA	FDC140VNA	FDC140VNA	FDC100VSA		
Power source			1 Phase 220-240V, 50Hz / 220V, 60Hz				3 Phase 380-415V, 50Hz / 380V, 60Hz		
Nominal cooling capacity (Min~Max)			kW	10.0 (4.0 ~ 11.2)	12.5 (5.0 ~ 14.0)	13.6 (5.0 ~ 14.5)	10.0 (4.0 ~ 11.2)		
Nominal heating capacity (Min~Max)			kW	11.2 (4.0 ~ 12.5)	14.0 (4.0 ~ 16.0)	15.5 (4.0 ~ 16.5)	11.2 (4.0 ~ 12.5)		
Power consumption			kW	3.25 / 3.21	4.53 / 3.75	5.02 / 4.20	3.25 / 3.21		
EER/COP				3.08 / 3.49	2.76 / 3.73	2.71 / 3.69	3.08 / 3.49		
Inrush current			A	5	5	5	5		
Max. current				26	26	27	17		
Sound power level*1	Indoor*2	Cooling/Heating	dB(A)	60 / 60	60 / 60	65 / 65	60 / 60	60 / 60	
	Outdoor	Cooling/Heating		70 / 70	71 / 71	73 / 73	73 / 73	70 / 70	
Sound pressure level*1	Indoor*2	Cooling (P-Hi/Hi/Me/Lo)		37 / 32 / 29 / 26	36 / 31 / 28 / 25	38 / 33 / 29 / 25	37 / 32 / 29 / 26	37 / 32 / 29 / 26	
		Heating (P-Hi/Hi/Me/Lo)		37 / 32 / 29 / 26	36 / 31 / 28 / 25	38 / 33 / 29 / 25	37 / 32 / 29 / 26	37 / 32 / 29 / 26	
	Outdoor	Cooling/Heating		54 / 56	55 / 57	57 / 59	57 / 59	54 / 56	
		Air flow		Cooling (P-Hi/Hi/Me/Lo)	13 / 10 / 9 / 8	20 / 15 / 13 / 10	24 / 19 / 15 / 10	13 / 10 / 9 / 8	13 / 10 / 9 / 8
	Heating (P-Hi/Hi/Me/Lo)	13 / 10 / 9 / 8	20 / 15 / 13 / 10	24 / 19 / 15 / 10	13 / 10 / 9 / 8	13 / 10 / 9 / 8			
	Outdoor	Cooling/Heating	75 / 73	75 / 73	75 / 73	75 / 73	75 / 73		
External static pressure*3			Pa	Standard:35 Max:100					
Exterior dimensions	Indoor	HeightxWidthxDepth	mm	280 x 750 x 635		280 x 950 x 635		280 x 750 x 635	
	Outdoor			845 x 970 x 370					
Net weight	Indoor		kg	29		34		29	
	Outdoor			80				82	
Ref.piping size			Liquid/Gas	ømm					
Refrigerant line (one way) length			m	9.52(3/8") / 15.88(5/8")					
Vertical height differences			Outdoor is higher/lower	Max.50					
Outdoor operating temperature range	Cooling	°C	Max.50 / Max.15						
	Heating		-15~50*4						
Air filter			-20~20						
Remote control (option)			Filter kit : UM-FL1EF / UM-FL2EF (option) wired:RC-EX3A, RC-E5, RCH-E3 wireless:RCN-KIT4-E2						

NOTES:

- The data are measured under the following conditions(ISO-T1).
Cooling:Indoor temp. of 27°CDB, 19°CWB, and outdoor temp. of 35°CDB. Heating:Indoor temp. of 20°CDB, and outdoor temp. of 7°CDB, 6°CWB.
- *1 : Indicates the value in an anechoic chamber. During operation these values are somewhat higher due to ambient conditions.
 - *2 : The values are for one indoor unit operation. (Multi system only)
 - *3 : External static pressure is changeable to be set by the remote control. MAX external static pressure is "High static pressure" setting. The values of sound pressure level become 5dB(A) higher at external static pressure of 100Pa.
 - *4 : If a cooling operation is conducted when the outdoor air temperature is -5°C or lower, the outdoor unit should be installed at a place where it is not influenced by natural wind. If wind blows, the low pressure will drop and compressor frequency will increase, this will cause the capacity to drop and may cause the unit to break down.

SPECIFICATIONS

The values are for simultaneous Multi operation.

Set model name		Micro Inverter						
		FDUM125VSAPVF	FDUM140VSAPVF1	FDUM200VSAPVF2	FDUM250VSAPVF	FDUM140VSATVF	FDUM200VSATVF1	
Indoor unit		FDUM60VF x 2	FDUM71VF1 x 2	FDUM100VF2 x 2	FDUM125VF x 2	FDUM50VF x 3	FDUM71VF1 x 3	
Outdoor unit		FDC125VSA	FDC140VSA	FDC200VSA	FDC250VSA	FDC140VSA	FDC200VSA	
Power source		3 Phase 380-415V, 50Hz / 380V, 60Hz						
Nominal cooling capacity (Min~Max)		kW 12.5 (5.0 ~ 14.0)	13.6 (5.0 ~ 14.5)	19.0 (5.2 ~ 22.4)	24.0 (6.9 ~ 28.0)	13.6 (5.0 ~ 14.5)	19.0 (5.2 ~ 22.4)	
Nominal heating capacity (Min~Max)		kW 14.0 (4.0 ~ 16.0)	15.5 (4.0 ~ 16.5)	22.4 (3.3 ~ 25.0)	27.0 (5.5 ~ 31.5)	15.5 (4.0 ~ 16.5)	22.4 (3.3 ~ 25.0)	
Power consumption		Cooling/Heating kW 4.53 / 3.75	5.02 / 4.20	6.51 / 6.04	8.33 / 7.52	5.02 / 4.20	6.46 / 6.15	
EER/COP		Cooling/Heating 2.76 / 3.73	2.71 / 3.69	2.92 / 3.71	2.88 / 3.59	2.71 / 3.69	2.94 / 3.64	
Inrush current		A	5	5	5	5	5	
Max. current			17	18	22	24	18	22
Sound power level*1	Indoor*2	Cooling/Heating	60 / 60	65 / 65	65 / 65	67 / 67	60 / 60	65 / 65
	Outdoor	Cooling/Heating	71 / 71	73 / 73	72 / 74	73 / 75	73 / 73	72 / 74
Sound pressure level*1	Indoor*2	Cooling (P-Hi/Hi/Me/Lo)	36 / 31 / 28 / 25	38 / 33 / 29 / 25	44 / 38 / 36 / 30	45 / 40 / 34 / 29	37 / 32 / 29 / 26	38 / 33 / 29 / 25
		Heating (P-Hi/Hi/Me/Lo)	36 / 31 / 28 / 25	38 / 33 / 29 / 25	44 / 38 / 36 / 30	45 / 40 / 34 / 29	37 / 32 / 29 / 26	38 / 33 / 29 / 25
	Outdoor	Cooling/Heating	55 / 57	57 / 59	58 / 59	59 / 62	57 / 59	58 / 59
		Cooling (P-Hi/Hi/Me/Lo)	20 / 15 / 13 / 10	24 / 19 / 15 / 10	36 / 28 / 25 / 19	39 / 32 / 26 / 20	13 / 10 / 9 / 8	24 / 19 / 15 / 10
Air flow	Outdoor	Heating (P-Hi/Hi/Me/Lo)	20 / 15 / 13 / 10	24 / 19 / 15 / 10	36 / 28 / 25 / 19	39 / 32 / 26 / 20	13 / 10 / 9 / 8	24 / 19 / 15 / 10
		Cooling/Heating	75 / 73	75 / 73	135 / 135	143 / 151	75 / 73	135 / 135
External static pressure*3		Pa	Standard:35 Max:100	Standard:60 Max:100	Standard:35 Max:100	Standard:35 Max:100	Standard:35 Max:100	
Exterior dimensions	Indoor	HeightxWidthxDepth	280 x 950 x 635		280 x 1,370 x 740		280 x 750 x 635	280 x 950 x 635
	Outdoor		845 x 970 x 370		1,300 x 970 x 370		845 x 970 x 370	1,300 x 970 x 370
Net weight	Indoor		34		54		29	34
	Outdoor		82		115 143		82	115
Ref.piping size		Liquid/Gas	ømm 9.52(3/8") / 15.88(5/8")		9.52(3/8") / 22.22(7/8") 12.7(1/2") / 22.22(7/8")		9.52(3/8") / 15.88(5/8")	9.52(3/8") / 22.22(7/8")
Refrigerant line (one way) length		m	Max.50		Max.70		Max.50	Max.70
Vertical height differences		Outdoor is higher/lower	m Max.50 / Max.15		Max.30 / Max.15		Max.50 / Max.15	Max.30 / Max.15
Outdoor operating temperature range		Cooling	°C -15~50**4					
		Heating	-20~20		-15~20		-20~20	-15~20
Air filter		Filter kit : UM-FL1EF / UM-FL2EF / UM-FL3EF (option)						
Remote control (option)		wired:RC-EX3A, RC-E5, RCH-E3 wireless:RCN-KIT4-E2						

Set model name		Standard Inverter				
		FDUM71VNPVF1	FDUM90VNP1VF2	FDUM100VNP1VF2		
Indoor unit		FDUM71VF1	FDUM100VF2	FDUM100VF2		
Outdoor unit		FDC71VNP	FDC90VNP1	FDC100VNP		
Power source		1 Phase 220-240V, 50Hz / 220V, 60Hz				
Nominal cooling capacity (Min~Max)		kW 7.1 (1.4 ~ 7.1)	9.0 (1.9 ~ 9.0)	10.0 (2.8 ~ 11.2)		
Nominal heating capacity (Min~Max)		kW 7.1 (1.0 ~ 7.1)	9.0 (1.5 ~ 9.0)	11.2 (2.5 ~ 12.5)		
Power consumption		Cooling/Heating kW 2.60 / 1.89	2.69 / 2.25	3.00 / 2.93		
EER/COP		Cooling/Heating 2.73 / 3.76	3.35 / 4.00	3.33 / 3.82		
Inrush current		A	5	5		
Max. current			14.5	18.0	22.0	
Sound power level*1	Indoor	Cooling/Heating	65 / 65	65 / 65	65 / 65	
	Outdoor	Cooling/Heating	67 / 67	69 / 69	70 / 70	
Sound pressure level*1	Indoor	Cooling (P-Hi/Hi/Me/Lo)	38 / 33 / 29 / 25	44 / 38 / 36 / 30	44 / 38 / 36 / 30	
		Heating (P-Hi/Hi/Me/Lo)	38 / 33 / 29 / 25	44 / 38 / 36 / 30	44 / 38 / 36 / 30	
	Outdoor	Cooling/Heating	54 / 54	57 / 55	57 / 61	
		Cooling (P-Hi/Hi/Me/Lo)	24 / 19 / 15 / 10	36 / 28 / 25 / 19	36 / 28 / 25 / 19	
Air flow	Outdoor	Heating (P-Hi/Hi/Me/Lo)	24 / 19 / 15 / 10	36 / 28 / 25 / 19	36 / 28 / 25 / 19	
		Cooling/Heating	36 / 36	63 / 49.5	75 / 79	
External static pressure*3		Pa	Standard:35 Max:100	Standard:60 Max:100		
Exterior dimensions	Indoor	HeightxWidthxDepth	280 x 950 x 635		280 x 1,370 x 740	
	Outdoor		640 x 800(+71) x 290		750 x 880(+88) x 340	845 x 970 x 370
Net weight	Indoor		34		54	
	Outdoor		45		70	
Ref.piping size		Liquid/Gas	ømm 6.35(1/4") / 12.7(1/2")		6.35(1/4") / 15.88(5/8")	9.52(3/8") / 15.88(5/8")
Refrigerant line (one way) length		m	Max.30			
Vertical height differences		Outdoor is higher/lower	m Max.20 / Max.20			
Outdoor operating temperature range		Cooling	°C -15~46**4			
		Heating	-15~20			
Air filter		Filter kit : UM-FL2EF / UM-FL3EF (option)				
Remote control (option)		wired:RC-EX3A, RC-E5, RCH-E3 wireless:RCN-KIT4-E2				

WALL MOUNTED SRK



Only used with Multi System.

SRK 50•60



Common to the both case of Single and Multi

SRK 100



*Not all functions are available with all remote control options.

Wired remote control (Option)



RC-EX3A



RC-E5



RCH-E3

Point 1 Elegant Timeless Design

The new SRK series air-conditioners have been stylishly designed with rounded contours that fit beautifully into any of Europe's diverse interior settings.

The design was created by the Italian industrial design studio Tensa srl, based in Milan, to respond to a broad spectrum of local user needs.

Point 2 Jet Technology

We used the same aerodynamic analysis technology as used in developing jet engines.

CFD (computational fluid dynamics), used in blade shape design of jet engines, has been applied to the design of air channels in air conditioners to develop the ideal air channel system (air circulation). The airflow of the jets created in this system enable a large volume of air to be blown with minimum power consumption, yet the air flow is uniform, quiet and reaches points a long distance from the blower.



(C) Mitsubishi Aircraft Corporation

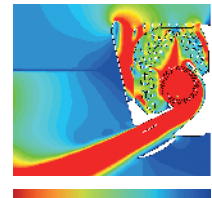

Fast ← → Slow
Colors in the figure show the air speed.

Point 3 Long Reach Air Flow

Powerful airflow is realized by Jet technology. Good for large living rooms and shops, which increase comfort.

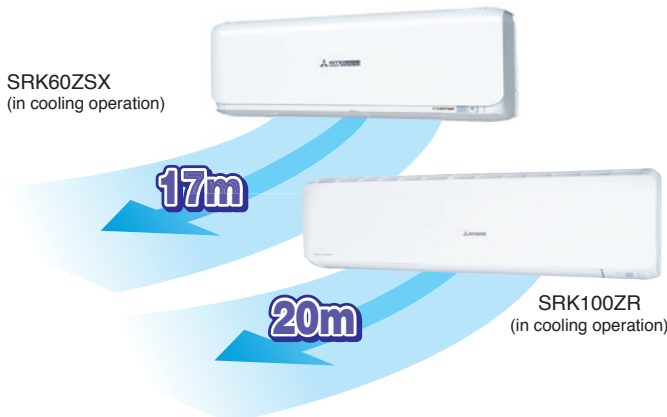

Point 4 Indoor unit connection

Max three indoor units are connectable to one outdoor unit.

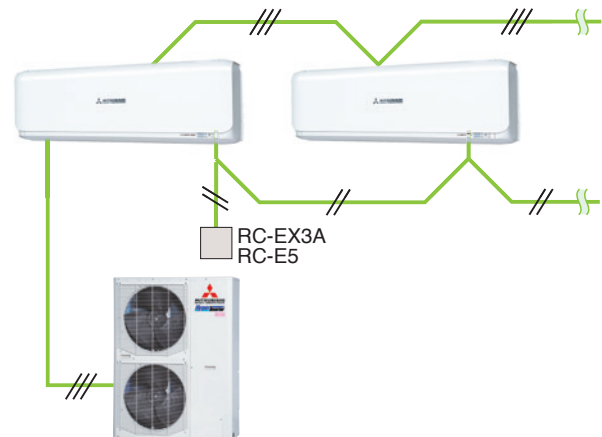

*SC-BIKN2-E is necessary to connect to wired remote controller.

Point 5 Flap control system

The flap can swing within the range of upper and lower flap position selected.

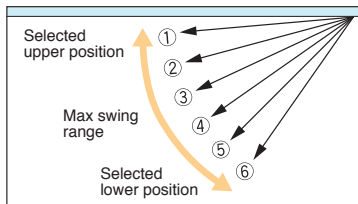

*The wireless remote control is not applicable to the flap control system.

Point 6 SC-BKN2-E connection (option)

Interface kit can be built into indoor unit.(SRK50~60)

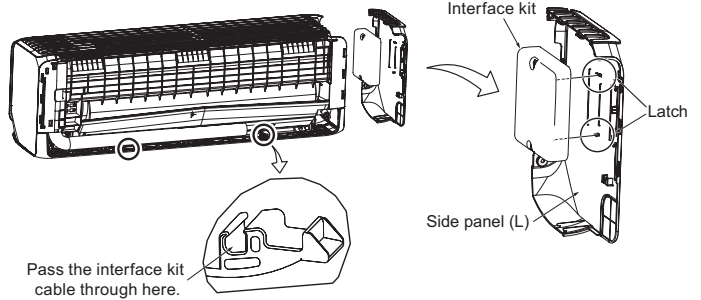

OUTDOOR UNIT

	<i>Hyper Inverter</i>	<i>Micro Inverter</i>	<i>Standard Inverter</i>
FDC	100~140VN(S)X	100~140VN(S)A	200VSA
model			
Chargeless	30m	30m	15m
Height x Width x Depth (mm)	1,300 x 970 x 370	845 x 970 x 370	1,300 x 970 x 370

DIMENSIONS (Unit:mm)

SRK50ZSX-W, 60ZSX-W

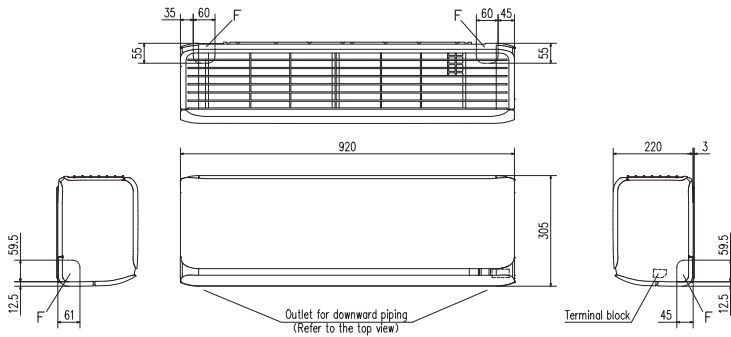

Symbol	Content
A	Gas piping φ12.7 (1/2") (Flare)
B	Liquid piping φ6.35 (1/4") (Flare)
C	Hole on wall for right rear piping (φ65)
D	Hole on wall for left rear piping (φ65)
E	Drain hose VP16
F	Outlet for piping

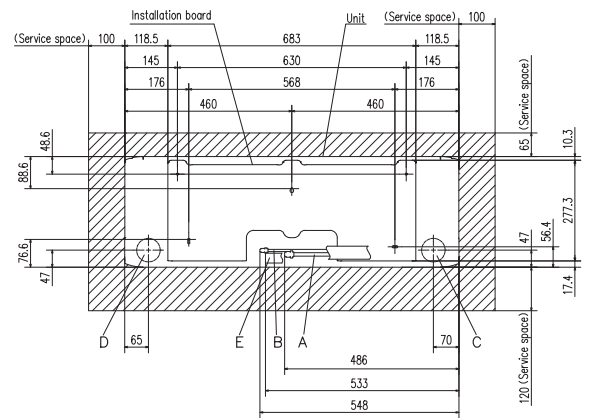

Space for installation and service when viewing from the front

SRK100ZR-S

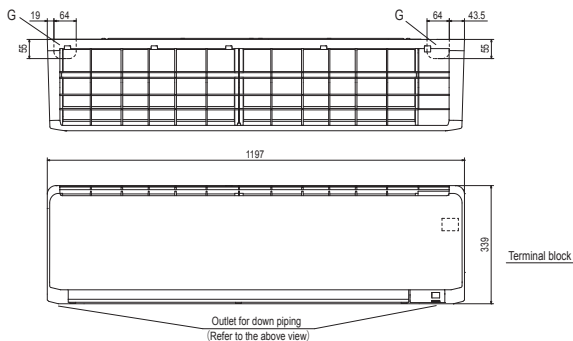

Symbol	Content
A	Gas piping φ15.88 (5/8") (Flare)
B	Liquid piping φ9.52 (3/8") (Flare)
C	Hole on wall for right rear piping (φ65)
D	Hole on wall for left rear piping (φ65)
E	Drain hose VP16
F	Outlet for wiring (on both side)
G	Outlet for piping (on both side)

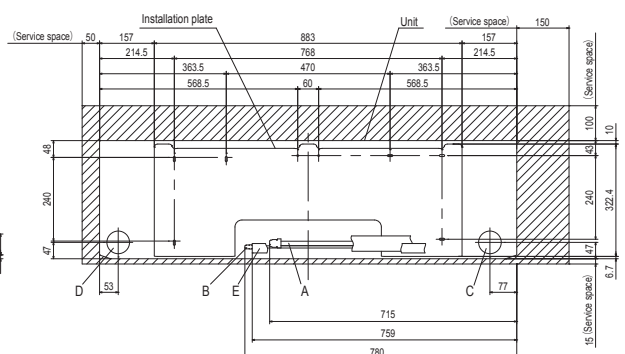

Space for installation and service when viewing from the front

SPECIFICATIONS

The values are for simultaneous Multi operation.

Set model name		Hyper Inverter					
		SRK100VNXPSZX	SRK125VNXPSZX	SRK140VNXPTZSX	SRK100VSPZSX	SRK125VSPZSX	SRK140VSPZSX
		Twin		Triple	Twin		Triple
Indoor unit		SRK50ZSX-W x 2	SRK60ZSX-W x 2	SRK50ZSX-W x 3	SRK50ZSX-W x 2	SRK60ZSX-W x 2	SRK50ZSX-W x 3
Outdoor unit		FDC100VNX	FDC125VNX	FDC140VNX	FDC100VNX	FDC125VNX	FDC140VNX
Power source		1 Phase 220-240V, 50Hz / 220V, 60Hz			3 Phase 380-415V, 50Hz / 380V, 60Hz		
Nominal cooling capacity (Min~Max)	kW	10.0 (4.0 ~ 11.2)	12.5 (5.0 ~ 14.0)	14.0 (5.0 ~ 16.0)	10.0 (4.0 ~ 11.2)	12.5 (5.0 ~ 14.0)	14.0 (5.0 ~ 16.0)
Nominal heating capacity (Min~Max)	kW	11.2 (4.0 ~ 12.5)	14.0 (4.0 ~ 17.0)	16.0 (4.0 ~ 18.0)	11.2 (4.0 ~ 16.0)	14.0 (4.0 ~ 18.0)	16.0 (4.0 ~ 20.0)
Power consumption	Cooling/Heating	2.66 / 2.60	3.60 / 3.48	3.98 / 3.68	2.66 / 2.60	3.60 / 3.48	3.98 / 3.68
EER/COP	Cooling/Heating	3.76 / 4.31	3.47 / 4.02	3.52 / 4.35	3.76 / 4.31	3.47 / 4.02	3.52 / 4.35
Inrush current	A	5	5	5	5	5	5
Max. current		24	26	26	15	15	15
Sound power level*1	Indoor*2	Cooling/Heating	59 / 62	62 / 63	59 / 62	59 / 62	62 / 63
	Outdoor	Cooling/Heating	70 / 70	70 / 70	72 / 72	70 / 70	72 / 72
Sound pressure level*1	Indoor*2	Cooling (Hi/Me/Lo/Ulo)	44 / 39 / 31 / 22	46 / 41 / 33 / 22	44 / 39 / 31 / 22	44 / 39 / 31 / 22	46 / 41 / 33 / 22
		Heating (Hi/Me/Lo/Ulo)	46 / 41 / 33 / 23	46 / 42 / 34 / 23	46 / 41 / 33 / 23	46 / 41 / 33 / 23	46 / 42 / 34 / 23
	Outdoor	Cooling/Heating	48 / 50	48 / 50	49 / 52	48 / 50	48 / 50
		Cooling/Heating	48 / 50	48 / 50	49 / 52	48 / 50	49 / 52
Air flow	Indoor*2	Cooling (Hi/Me/Lo/Ulo)	14.3 / 12.4 / 7.8 / 5.4	16.3 / 13.4 / 8.9 / 5.4	14.3 / 12.4 / 7.8 / 5.4	14.3 / 12.4 / 7.8 / 5.4	16.3 / 13.4 / 8.9 / 5.4
		Heating (Hi/Me/Lo/Ulo)	17.3 / 14.3 / 9.8 / 6.2	17.8 / 13.7 / 10.9 / 6.2	17.3 / 14.3 / 9.8 / 6.2	17.3 / 14.3 / 9.8 / 6.2	17.8 / 13.7 / 10.9 / 6.2
	Outdoor	Cooling/Heating	100 / 100	100 / 100	100 / 100	100 / 100	100 / 100
Exterior dimensions	Indoor	HeightxWidthxDepth	305 x 920 x 220				
	Outdoor	HeightxWidthxDepth	1,300 x 970 x 370				
Net weight	Indoor		13				
	Outdoor		105				
Ref.piping size	Liquid/Gas	ømm	9.52(3/8") / 15.88(5/8")				
Refrigerant line (one way) length		m	Max.100				
Vertical height differences	Outdoor is higher/lower	m	Max.30 / Max.15				
Outdoor operating temperature range	Cooling	°C	-15~43*3				
	Heating	°C	-20~20				
Air filter, Q'ty			Polypropylene net x 2(washable)				
Remote control (option)			wired:RC-EX3A, RC-E5, RCH-E3 & Interface kit:SC-BIKN2-E				

Set model name		Micro Inverter	
		SRK100VNAZR	SRK100VSAZR
Indoor unit		SRK100ZR-S	SRK100ZR-S
Outdoor unit		FDC100VNA	FDC100VSA
Power source		1 Phase 220-240V, 50Hz / 220V, 60Hz	3 Phase 380-415V, 50Hz / 380V, 60Hz
Nominal cooling capacity (Min~Max)	kW	10.0 (4.0 ~ 11.2)	10.0 (4.0 ~ 11.2)
Nominal heating capacity (Min~Max)	kW	11.2 (4.0 ~ 12.5)	11.2 (4.0 ~ 12.5)
Power consumption	Cooling/Heating	3.19 / 2.78	3.19 / 2.78
EER/COP	Cooling/Heating	3.13 / 4.03	3.13 / 4.03
Inrush current	A	5	5
Max. current		24	15
Sound power level*1	Indoor	Cooling/Heating	63 / 63
	Outdoor	Cooling/Heating	70 / 70
Sound pressure level*1	Indoor	Cooling (Hi/Me/Lo/Ulo)	48 / 45 / 40 / 27
		Heating (Hi/Me/Lo/Ulo)	48 / 43 / 38 / 30
	Outdoor	Cooling/Heating	54 / 56
		Cooling/Heating	54 / 56
Air flow	Indoor	Cooling (Hi/Me/Lo/Ulo)	24.5 / 21.3 / 17.6 / 10.4
		Heating (Hi/Me/Lo/Ulo)	27.5 / 23.2 / 19.1 / 13.6
	Outdoor	Cooling/Heating	75 / 73
Exterior dimensions	Indoor	HeightxWidthxDepth	339 / 1,197 / 262
	Outdoor	HeightxWidthxDepth	845 / 970 / 370
Net weight	Indoor		16.5
	Outdoor		82
Ref.piping size	Liquid/Gas	ømm	9.52(3/8") / 15.88(5/8")
Refrigerant line (one way) length		m	Max.50
Vertical height differences	Outdoor is higher/lower	m	Max.50 / Max.15
Outdoor operating temperature range	Cooling	°C	-15~50*3
	Heating	°C	-20~20
Air filter, Q'ty			Polypropylene net x2 (Washable)
Remote control (option)			wired:RC-EX3A, RC-E5, RCH-E3 & Interface kit:SC-BIKN2-E

NOTES:

The data are measured under the following conditions (ISO-T1).

Cooling:Indoor temp. of 27°CDB, 19°CWB, and outdoor temp. of 35°CDB. Heating:Indoor temp. of 20°CDB, and outdoor temp. of 7°CDB, 6°CWB.

*1 : Indicates the value in an anechoic chamber. During operation these values are somewhat higher due to ambient conditions.

*2 : The values are for one indoor unit operation. (Multi system only)

*3 : If a cooling operation is conducted when the outdoor air temperature is -5°C or lower, the outdoor unit should be installed at a place where it is not influenced by natural wind. If wind blows, the low pressure will drop and compressor frequency will increase, this will cause the capacity to drop and may cause the unit to break down.

SPECIFICATIONS

The values are for simultaneous Multi operation.(except Single case)

				Micro Inverter	Standard Inverter
Set model name				SRK200VSAPZR	SRK100VNP1ZR
				Twin	
Indoor unit				SRK100ZR-S x 2	SRK100ZR-S
Outdoor unit				FDC200VSA	FDC100VNP
Power source				3 Phase 380-415V, 50Hz / 380V, 60Hz	1 Phase 220-240V, 50Hz / 220V, 60Hz
Nominal cooling capacity (Min~Max)		kW		19.0 (5.2 ~ 22.4)	10.0 (2.4 ~ 10.5)
Nominal heating capacity (Min~Max)		kW		22.4 (3.3 ~ 25.0)	11.2 (3.2 ~ 11.5)
Power consumption		Cooling/Heating	kW	7.52 / 7.41	3.09 / 3.28
EER/COP		Cooling/Heating		2.53 / 3.02	3.24 / 3.41
Inrush current			A	5	14.4
Max. current				20	21
Sound power level* ¹	Indoor* ²	Cooling/Heating		63 / 63	63 / 63
	Outdoor	Cooling/Heating		72 / 74	70 / 74
Sound pressure level* ¹	Indoor* ²	Cooling (Hi/Me/Lo/Ulo)	dB(A)	48 / 45 / 40 / 27	48 / 45 / 40 / 27
		Heating (Hi/Me/Lo/Ulo)		48 / 43 / 38 / 30	48 / 43 / 38 / 30
	Outdoor	Cooling/Heating		58 / 59	57 / 61
Air flow	Indoor* ²	Cooling (Hi/Me/Lo/Ulo)	m ³ /min	24.5 / 21.3 / 17.6 / 10.4	24.5 / 21.3 / 17.6
		Heating (Hi/Me/Lo/Ulo)		27.5 / 23.2 / 19.1 / 13.6	27.5 / 23.2 / 19.1
	Outdoor	Cooling/Heating		135 / 135	75 / 80
Exterior dimensions	Indoor	HeightxWidthxDepth	mm	339 x 1,197 x 262	
	Outdoor			1,300 x 970 x 370	845 x 970 x 370
Net weight	Indoor		kg	16.5	
	Outdoor			115	70
Ref.piping size	Liquid/Gas		ømm	9.52(3/8") / 22.22(7/8")	9.52(3/8") / 15.88(5/8")
Refrigerant line (one way) length			m	Max.70	Max.30
Vertical height differences		Outdoor is higher/lower	m	Max.30 / Max.15	Max.20 / Max.20
Outdoor operating temperature range		Cooling	°C	-15~50* ³	-15~46* ³
		Heating		-15~20	
Air filter, Q'ty		Polypropylene net x2 (Washable)			
Remote control (option)		wired:RC-EX3A, RC-E5, RCH-E3 & Interface kit:SC-BIKN2-E			

CEILING SUSPENDED FDE



FDE 40/50/60/71/100/125/140

Remote control (option)

Wired

Wireless

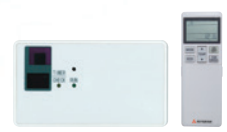

RC-EX3A

RC-E5

RCH-E3

RCN-E-E3



*Not all functions are available with all remote control options.

Point 1 High efficiency

Energy efficiency was improved by use of DC fan motor & high efficient heat exchanger.

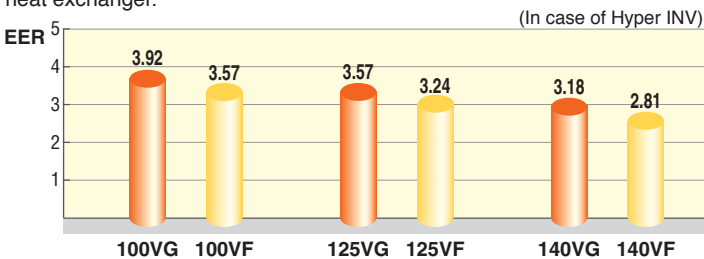

Point 2 Reduction of weight

Thanks to decreasing the numbers of fan motor from two to one, reduction of weight was achieved.

	Previous	Current	
60-71VG	37	33	4kg less!!
100-125-140VG	49	43	6kg less!!

Point 3 More quiet noise

The industry's lowest sound pressure levels were achieved by decreasing air flow volume, decreasing pressure loss with employment of one fan motor and optimizing casing and distributor shape.

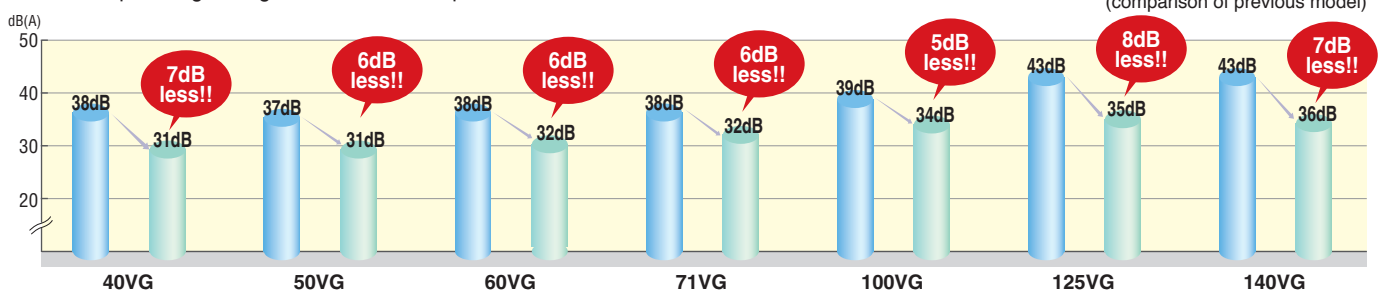

Point 4 Flap control system

The flap can swing within the range of upper and lower flap position selected.

*The wireless remote control is not applicable to the flap control system.

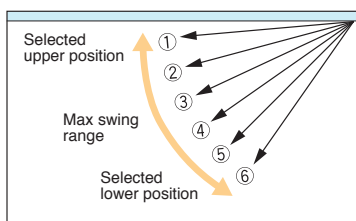







Point 5 Improved installation workability



Increased freedom of a piping layout

The refrigerant pipe from the unit can be arranged in three directions, rear, right and up. The drain pipe can be arranged in two directions, left and right. This will allow a free layout of piping for various installation conditions. The unit can only be serviced from the bottom.



OUTDOOR UNIT

SRC • FDC	Hyper Inverter			Micro Inverter		
	40~60ZSX	71VNX	100~140VN(S)X	100~140VN(S)A	200VSA	250VSA
model						
Chargeless	15m	30m		30m		
Height x Width x Depth (mm)	640 x 800(+71) x 290	750 x 880(+88) x 340	1,300 x 970 x 370	845 x 970 x 370	1,300 x 970 x 370	1,505 x 970 x 370

FDC	Standard Inverter		
	71VNP	90VNP1	100VNP
model			
Chargeless	15m		
Height x Width x Depth (mm)	640 x 800(+71) x 290	750 x 880(+88) x 340	845 x 970 x 370

DIMENSIONS (Unit:mm)

Models FDE40VG, 50VG

Symbol	Content	
A	Gas piping	ø12.7 (1/2") (Flare)
B	Liquid piping	ø6.35 (1/4") (Flare)
C 1,2	Drain piping	VP20 (I.D.20, O.D.26)
D	Hole for suspension bolts	(M10 or M8)
E	Back cutout	PE cover
F	Top cutout	Plate cover
G	Drain piping (for left back)	(Knock out)

Note (1) The model name label is attached on the fan casing inside the air return grille.

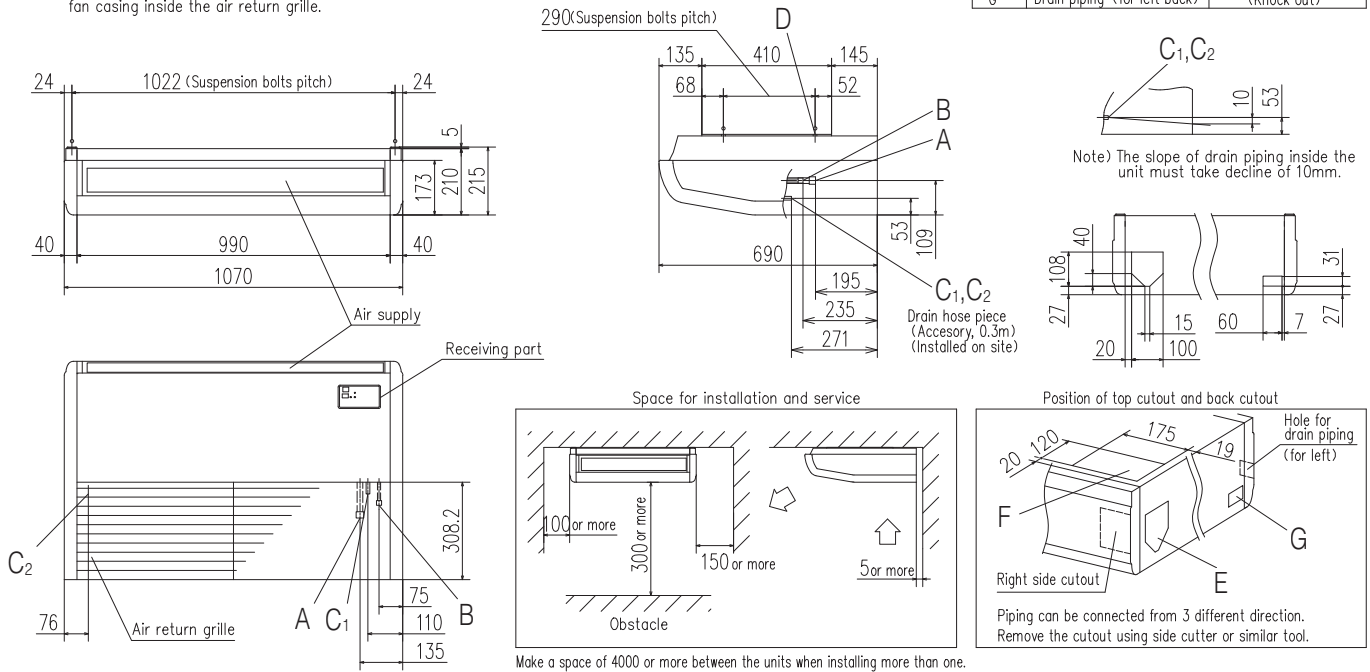

DIMENSIONS (Unit:mm)

Models FDE60VG, 71VG

Note (1) The model name label is attached on the fan casing inside the air return grille.

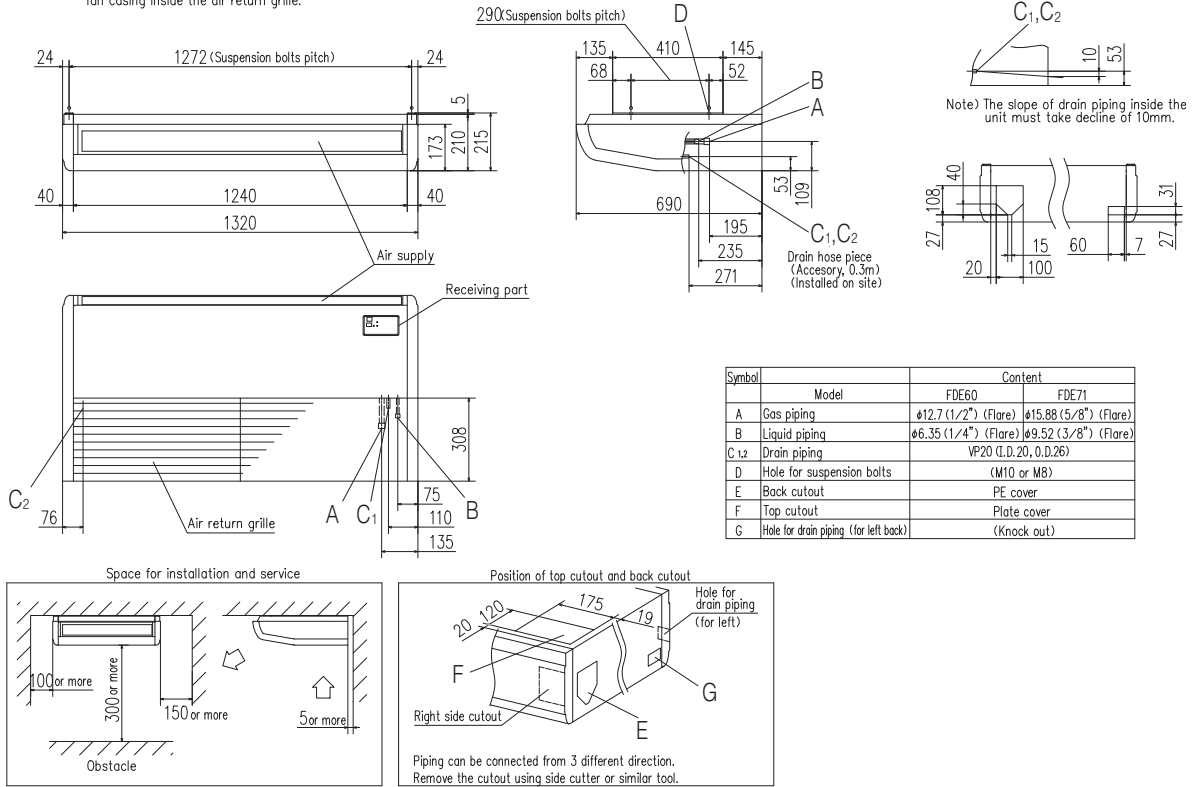

Make a space of 4500 or more between the units when installing more than one.

Models FDE100VG, 125VG, 140VG

Note (1) The model name label is attached on the fan casing inside the air return grille.

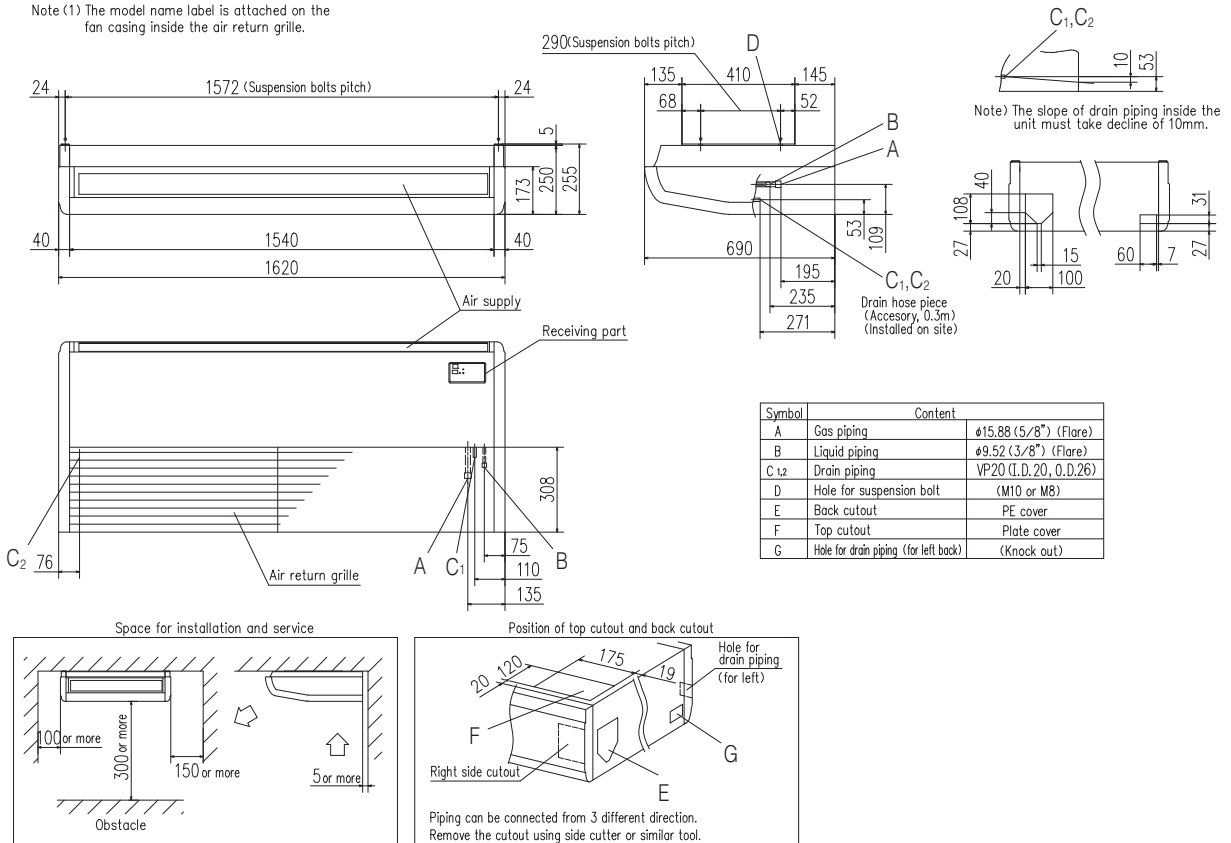

Make a space of 5000 or more between the units when installing more than one.

SPECIFICATIONS

		<i>HyperInverter</i>				
Set model name		FDE40ZSXVG	FDE50ZSXVG	FDE60ZSXVG	FDE71VNXVG	FDE100VNXVG
Indoor unit		FDE40VG	FDE50VG	FDE60VG	FDE71VG	FDE100VG
Outdoor unit		SRC40ZSX-S	SRC50ZSX-S	SRC60ZSX-S	FDC71VNX	FDC100VNX
Power source		1 Phase 220-240V, 50Hz / 220V, 60Hz				
Nominal cooling capacity (Min~Max)		kW 4.0 (1.1 ~ 4.7)	5.0 (1.1 ~ 5.6)	5.6 (1.1 ~ 6.3)	7.1 (3.2 ~ 8.0)	10.0 (4.0 ~ 11.2)
Nominal heating capacity (Min~Max)		kW 4.5 (0.6 ~ 5.4)	5.4 (0.6 ~ 6.3)	6.7 (0.6 ~ 7.1)	8.0 (3.6 ~ 9.0)	11.2 (4.0 ~ 12.5)
Power consumption		Cooling/Heating kW 1.02 / 1.10	1.52 / 1.46	1.75 / 1.86	2.11 / 2.11	2.55 / 2.68
EER/COP		Cooling/Heating 3.92 / 4.09	3.29 / 3.70	3.20 / 3.60	3.36 / 3.79	3.92 / 4.18
Inrush current		A				
Max. current		5	5	5	5	5
		12	15	15	17	24
Sound power level*1	Indoor	Cooling/Heating	60 / 60	60 / 60	60 / 60	64 / 64
	Outdoor	Cooling/Heating	63 / 63	63 / 63	65 / 64	66 / 66
Sound pressure level*1	Indoor	Cooling (P-Hi/Hi/Me/Lo)	46 / 38 / 36 / 31	46 / 38 / 36 / 31	47 / 41 / 37 / 32	47 / 41 / 37 / 32
		Heating (P-Hi/Hi/Me/Lo)	46 / 38 / 36 / 31	46 / 38 / 36 / 31	47 / 41 / 37 / 32	47 / 41 / 37 / 32
	Outdoor	Cooling/Heating	50 / 49	50 / 49	52 / 52	51 / 48
		dB(A)	48 / 43 / 38 / 34	48 / 43 / 38 / 34	48 / 43 / 38 / 34	48 / 43 / 38 / 34
Air flow	Indoor	Cooling (P-Hi/Hi/Me/Lo)	13 / 10 / 9 / 7	13 / 10 / 9 / 7	20 / 16 / 13 / 10	20 / 16 / 13 / 10
		Heating (P-Hi/Hi/Me/Lo)	13 / 10 / 9 / 7	13 / 10 / 9 / 7	20 / 16 / 13 / 10	20 / 16 / 13 / 10
	Outdoor	Cooling/Heating	36 / 33	40 / 33	41.5 / 39	60 / 50
Exterior dimensions	Indoor	HeightxWidthxDepth	210 x 1,070 x 690		210 x 1,320 x 690	
	Outdoor	HeightxWidthxDepth	640 x 800(+71) x 290		750 x 880(+88) x 340	
Net weight	Indoor	kg	28		33	
	Outdoor	kg	45		60	
Ref.piping size	Liquid/Gas	ømm	6.35(1/4") / 12.7(1/2")		9.52(3/8") / 15.88(5/8")	
Refrigerant line (one way) length		m	Max.30		Max.50 / Max.100	
Vertical height differences	Outdoor is higher/lower	m	Max.20 / Max.20		Max.30 / Max.15	
Outdoor operating temperature range	Cooling	°C	-15~46*2		-15~43*2	
	Heating	°C	-20~24		-20~20	
Air filter, Q'ty			Pocket Plastic net x2(Washable)			
Remote control (option)			wired:RC-EX3A, RC-E5, RCH-E3 wireless:RCN-E-E3			

		<i>HyperInverter</i>				
Set model name		FDE125VNXVG	FDE140VNXVG	FDE100VSXVG	FDE125VSXVG	FDE140VSXVG
Indoor unit		FDE125VG	FDE140VG	FDE100VG	FDE125VG	FDE140VG
Outdoor unit		FDC125VNX	FDC140VNX	FDC100VSX	FDC125VSX	FDC140VSX
Power source		1 Phase 220-240V, 50Hz / 220V, 60Hz				
Nominal cooling capacity (Min~Max)		kW 12.5 (5.0 ~ 14.0)	14.0 (5.0 ~ 16.0)	10.0 (4.0 ~ 11.2)	12.5 (5.0 ~ 14.0)	14.0 (5.0 ~ 16.0)
Nominal heating capacity (Min~Max)		kW 14.0 (4.0 ~ 17.0)	16.0 (4.0 ~ 18.0)	11.2 (4.0 ~ 16.0)	14.0 (4.0 ~ 18.0)	16.0 (4.0 ~ 20.0)
Power consumption		Cooling/Heating kW 3.50 / 3.77	4.40 / 4.69	2.55 / 2.68	3.50 / 3.77	4.40 / 4.69
EER/COP		Cooling/Heating 3.57 / 3.71	3.18 / 3.41	3.92 / 4.18	3.57 / 3.71	3.18 / 3.41
Inrush current		A				
Max. current		5	5	5	5	5
		26	26	15	15	15
Sound power level*1	Indoor	Cooling/Heating	64 / 64	65 / 65	64 / 64	64 / 64
	Outdoor	Cooling/Heating	70 / 70	72 / 72	70 / 70	70 / 70
Sound pressure level*1	Indoor	Cooling (P-Hi/Hi/Me/Lo)	48 / 45 / 40 / 35	49 / 45 / 40 / 36	48 / 43 / 38 / 34	48 / 45 / 40 / 35
		Heating (P-Hi/Hi/Me/Lo)	48 / 45 / 40 / 35	49 / 45 / 40 / 36	48 / 43 / 38 / 34	48 / 45 / 40 / 35
	Outdoor	Cooling/Heating	48 / 50	49 / 52	48 / 50	48 / 50
		dB(A)	49 / 45 / 40 / 36	49 / 45 / 40 / 36	48 / 43 / 38 / 34	48 / 45 / 40 / 35
Air flow	Indoor	Cooling (P-Hi/Hi/Me/Lo)	32 / 29 / 23 / 17	34 / 29 / 23 / 18	32 / 26 / 21 / 16.5	32 / 29 / 23 / 17
		Heating (P-Hi/Hi/Me/Lo)	32 / 29 / 23 / 17	34 / 29 / 23 / 18	32 / 26 / 21 / 16.5	32 / 29 / 23 / 17
	Outdoor	Cooling/Heating	100 / 100	100 / 100	100 / 100	100 / 100
Exterior dimensions	Indoor	HeightxWidthxDepth	250 x 1,620 x 690			
	Outdoor	HeightxWidthxDepth	1,300 x 970 x 370			
Net weight	Indoor	kg	43			
	Outdoor	kg	105			
Ref.piping size	Liquid/Gas	ømm	9.52(3/8") / 15.88(5/8")			
Refrigerant line (one way) length		m	Max.100			
Vertical height differences	Outdoor is higher/lower	m	Max.30 / Max.15			
Outdoor operating temperature range	Cooling	°C	-15~43*3			
	Heating	°C	-20~20			
Air filter, Q'ty			Pocket Plastic net x2(Washable)			
Remote control (option)			wired:RC-EX3A, RC-E5, RCH-E3 wireless:RCN-E-E3			

NOTES:

The data are measured under the following conditions(ISO-T1).

Cooling:Indoor temp. of 27°CDB, 19°CWB, and outdoor temp. of 35°CDB. Heating:Indoor temp. of 20°CDB, and outdoor temp. of 7°CDB, 6°CWB.

*1 : Indicates the value in an anechoic chamber. During operation these values are somewhat higher due to ambient conditions.

*2 : If a cooling operation is conducted when the outdoor air temperature is -5°C or lower, the outdoor unit should be installed at a place where it is not influenced by natural wind. If wind blows, the low pressure will drop and compressor frequency will increase, this will cause the capacity to drop and may cause the unit to break down.

SPECIFICATIONS

The values are for simultaneous Multi operation.

Set model name		Hyper Inverter				
		FDE71VNXPGV	FDE100VNXPGV	FDE125VNXPGV	FDE140VNXPGV	FDE140VNXTVG
		Twin				Triple
Indoor unit		FDE40VG x 2	FDE50VG x 2	FDE60VG x 2	FDE71VG x 2	FDE50VG x 3
Outdoor unit		FDC71VNX	FDC100VNX	FDC125VNX	FDC140VNX	FDC140VNX
Power source		1 Phase 220-240V, 50Hz / 220V, 60Hz				
Nominal cooling capacity (Min~Max)	kW	7.1 (3.2 ~ 8.0)	10.0 (4.0 ~ 11.2)	12.5 (5.0 ~ 14.0)	14.0 (5.0 ~ 16.0)	14.0 (5.0 ~ 16.0)
Nominal heating capacity (Min~Max)	kW	8.0 (3.6 ~ 9.0)	11.2 (4.0 ~ 12.5)	14.0 (4.0 ~ 17.0)	16.0 (4.0 ~ 18.0)	16.0 (4.0 ~ 18.0)
Power consumption	Cooling/Heating	2.05 / 2.35	3.00 / 3.39	3.97 / 3.70	4.67 / 4.58	4.66 / 4.53
EER/COP	Cooling/Heating	3.46 / 3.40	3.33 / 3.30	3.15 / 3.78	3.00 / 3.49	3.00 / 3.53
Inrush current		5	5	5	5	5
Max. current		17	24	26	26	26
Sound power level*1	Indoor*2	Cooling/Heating	60 / 60	60 / 60	60 / 60	60 / 60
	Outdoor	Cooling/Heating	66 / 66	70 / 70	70 / 70	72 / 72
Sound pressure level*1	Indoor*2	Cooling (P-Hi/Hi/Me/Lo)	46 / 38 / 36 / 31	46 / 38 / 36 / 31	47 / 41 / 37 / 32	46 / 38 / 36 / 31
	Outdoor	Cooling/Heating	51 / 48	48 / 50	48 / 50	49 / 52
Air flow	Indoor*2	Cooling (P-Hi/Hi/Me/Lo)	13 / 10 / 9 / 7	13 / 10 / 9 / 7	20 / 16 / 13 / 10	13 / 10 / 9 / 7
	Outdoor	Cooling/Heating	60 / 50	100 / 100	100 / 100	100 / 100
Exterior dimensions	Indoor	HeightxWidthxDepth	210 x 1,070 x 690		210 x 1,320 x 690	
	Outdoor		750 x 880(+88) x 340		1,300 x 970 x 370	
Net weight	Indoor		28		33	
	Outdoor		60		105	
Ref.piping size	Liquid/Gas	ømm 9.52(3/8") / 15.88(5/8")				
Refrigerant line (one way) length		Max. 50		Max. 100		
Vertical height differences	Outdoor is higher/lower	m Max.30 / Max.15				
Outdoor operating temperature range	Cooling	°C -15~43*3				
	Heating	°C -20~20				
Air filter, Q'ty		Pocket plastic net x 2(Washable)				
Remote control (option)		wired:RC-EX3A, RC-E5, RCH-E3 wireless:RCN-E-E3				

The values are for simultaneous Multi operation.

Set model name		Hyper Inverter				
		FDE100VSXPGV	FDE125VSXPGV	FDE140VSXPGV	FDE140VSXTVG	
		Twin			Triple	
Indoor unit		FDE50VG x 2	FDE60VG x 2	FDE71VG x 2	FDE50VG x 3	
Outdoor unit		FDC100VSX	FDC125VSX	FDC140VSX	FDC140VSX	
Power source		3 Phase 380-415V, 50Hz / 380V, 60Hz				
Nominal cooling capacity (Min~Max)	kW	10.0 (4.0 ~ 11.2)	12.5 (5.0 ~ 14.0)	14.0 (5.0 ~ 16.0)	14.0 (5.0 ~ 16.0)	
Nominal heating capacity (Min~Max)	kW	11.2 (4.0 ~ 16.0)	14.0 (4.0 ~ 18.0)	16.0 (4.0 ~ 20.0)	16.0 (4.0 ~ 20.0)	
Power consumption	Cooling/Heating	3.00 / 3.39	3.97 / 3.70	4.67 / 4.58	4.66 / 4.53	
EER/COP	Cooling/Heating	3.33 / 3.30	3.15 / 3.78	3.00 / 3.49	3.00 / 3.53	
Inrush current		5	5	5	5	
Max. current		15	15	15	15	
Sound power level*1	Indoor*2	Cooling/Heating	60 / 60	60 / 60	60 / 60	
	Outdoor	Cooling/Heating	70 / 70	70 / 70	72 / 72	
Sound pressure level*1	Indoor*2	Cooling (P-Hi/Hi/Me/Lo)	46 / 38 / 36 / 31	47 / 41 / 37 / 32	46 / 38 / 36 / 31	
	Outdoor	Cooling/Heating	48 / 50	48 / 50	49 / 52	
Air flow	Indoor*2	Cooling (P-Hi/Hi/Me/Lo)	13 / 10 / 9 / 7	20 / 16 / 13 / 10	13 / 10 / 9 / 7	
	Outdoor	Cooling/Heating	100 / 100	100 / 100	100 / 100	
Exterior dimensions	Indoor	HeightxWidthxDepth	210 x 1,070 x 690		210 x 1,320 x 690	
	Outdoor				1,300 x 970 x 370	
Net weight	Indoor		28		33	
	Outdoor				105	
Ref.piping size	Liquid/Gas	ømm 9.52(3/8") / 15.88(5/8")				
Refrigerant line (one way) length		m Max.100				
Vertical height differences	Outdoor is higher/lower	m Max.30 / Max.15				
Outdoor operating temperature range	Cooling	°C -15~43*3				
	Heating	°C -20~20				
Air filter, Q'ty		Pocket plastic net x 2(Washable)				
Remote control (option)		wired:RC-EX3A, RC-E5, RCH-E3 wireless:RCN-E-E3				

NOTES:

The data are measured under the following conditions(ISO-T1).
 Cooling:Indoor temp. of 27°CDB, 19°CWB, and outdoor temp. of 35°CDB. Heating:Indoor temp. of 20°CDB, and outdoor temp. of 7°CDB, 6°CWB.
 *1 : Indicates the value in an anechoic chamber. During operation these values are somewhat higher due to ambient conditions.
 *2 : The values are for one indoor unit operation. (Multi system only)
 *3 : If a cooling operation is conducted when the outdoor air temperature is -5°C or lower, the outdoor unit should be installed at a place where it is not influenced by natural wind. If wind blows, the low pressure will drop and compressor frequency will increase, this will cause the capacity to drop and may cause the unit to break down.

SPECIFICATIONS

			Micro Inverter								
Set model name			FDE100VNAVg	FDE125VNAVg	FDE140VNAVg	FDE100VSAVg	FDE125VSAVg	FDE140VSAVg			
Indoor unit			FDE100VG	FDE125VG	FDE140VG	FDE100VG	FDE125VG	FDE140VG			
Outdoor unit			FDC100VNA	FDC125VNA	FDC140VNA	FDC100VSA	FDC125VSA	FDC140VSA			
Power source			1 Phase 220-240V, 50Hz / 220V, 60Hz			3 Phase 380-415V, 50Hz / 380V, 60Hz					
Nominal cooling capacity (Min~Max)			kW	10.0 (4.0 ~ 11.2)	12.5 (5.0 ~ 14.0)	13.6 (5.0 ~ 14.5)	10.0 (4.0 ~ 11.2)	12.5 (5.0 ~ 14.0)	13.6 (5.0 ~ 14.5)		
Nominal heating capacity (Min~Max)			kW	11.2 (4.0 ~ 12.5)	14.0 (4.0 ~ 16.0)	15.5 (4.0 ~ 16.5)	11.2 (4.0 ~ 12.5)	14.0 (4.0 ~ 16.0)	15.5 (4.0 ~ 16.5)		
Power consumption			kW	Cooling/Heating		2.85 / 2.70	4.45 / 3.74	5.21 / 4.42	2.85 / 2.70	4.45 / 3.74	5.21 / 4.42
EER/COP				Cooling/Heating		3.51 / 4.15	2.81 / 3.74	2.61 / 3.51	3.51 / 4.15	2.81 / 3.74	2.61 / 3.51
Inrush current			A			5	5	5	5	5	5
Max. current						24	24	24	15	15	15
Sound power level*1			Indoor	Cooling/Heating		64 / 64	64 / 64	65 / 65	64 / 64	64 / 64	65 / 65
				Outdoor	Cooling/Heating		70 / 70	71 / 71	73 / 73	70 / 70	71 / 71
Sound pressure level*1			Indoor		Cooling (P-Hi/Hi/Me/Lo)		48 / 43 / 38 / 34	48 / 45 / 40 / 35	49 / 45 / 40 / 36	48 / 43 / 38 / 34	48 / 45 / 40 / 35
				Outdoor	Heating (P-Hi/Hi/Me/Lo)		48 / 43 / 38 / 34	48 / 45 / 40 / 35	49 / 45 / 40 / 36	48 / 43 / 38 / 34	48 / 45 / 40 / 35
			Indoor		Cooling/Heating		54 / 56	55 / 57	57 / 59	54 / 56	55 / 57
				Outdoor	Cooling (P-Hi/Hi/Me/Lo)		32 / 26 / 21 / 16.5	32 / 29 / 23 / 17	34 / 29 / 23 / 18	32 / 26 / 21 / 16.5	32 / 29 / 23 / 17
			Outdoor		Heating (P-Hi/Hi/Me/Lo)		32 / 26 / 21 / 16.5	32 / 29 / 23 / 17	34 / 29 / 23 / 18	32 / 26 / 21 / 16.5	32 / 29 / 23 / 17
Exterior dimensions				Indoor	HeightxWidthxDepth	mm	250 x 1,620 x 690				
			Outdoor			845 x 970 x 370					
Net weight			Indoor		kg	43					
			Outdoor			80			82		
Ref.piping size			Liquid/Gas		ømm	9.52(3/8") / 15.88(5/8")					
Refrigerant line (one way) length					m	Max.50					
Vertical height differences			Outdoor is higher/lower		m	Max.50 / Max.15					
Outdoor operating temperature range			Cooling		°C	-15~50*3					
			Heating			-20~20					
Air filter, Q'ty			Pocket Plastic net x2(Washable)								
Remote control (option)			wired:RC-EX3A, RC-E5, RCH-E3 wireless:RCN-E-E3								

The values are for simultaneous Multi operation.

			Micro Inverter								
Set model name			FDE100VNAPVg	FDE125VNAPVg	FDE140VNAPVg	FDE140VNATVg	FDE100VSAPVg	FDE125VSAPVg			
Indoor unit			FDE50VG x 2	FDE60VG x 2	FDE71VG x 2	FDE50VG x 3	FDE50VG x 2	FDE60VG x 2			
Outdoor unit			FDC100VNA	FDC125VNA	FDC140VNA	FDC140VNA	FDC100VSA	FDC125VSA			
Power source			1 Phase 220-240V, 50Hz / 220V, 60Hz			3 Phase 380-415V, 50Hz / 380V, 60Hz					
Nominal cooling capacity (Min~Max)			kW	10.0 (4.0 ~ 11.2)	12.5 (5.0 ~ 14.0)	13.6 (5.0 ~ 14.5)	13.6 (5.0 ~ 14.5)	10.0 (4.0 ~ 11.2)	12.5 (5.0 ~ 14.0)		
Nominal heating capacity (Min~Max)			kW	11.2 (4.0 ~ 12.5)	14.0 (4.0 ~ 16.0)	15.5 (4.0 ~ 16.5)	15.5 (4.0 ~ 16.5)	11.2 (4.0 ~ 12.5)	14.0 (4.0 ~ 16.0)		
Power consumption			kW	Cooling/Heating		3.12 / 2.99	4.16 / 3.54	4.74 / 4.21	4.74 / 4.21	3.12 / 2.99	4.16 / 3.54
EER/COP				Cooling/Heating		3.21 / 3.75	3.00 / 3.95	2.87 / 3.68	2.87 / 3.68	3.21 / 3.75	3.00 / 3.95
Inrush current			A			5	5	5	5	5	5
Max. current						24	24	24	24	15	15
Sound power level*1			Indoor*2	Cooling/Heating		60 / 60	60 / 60	60 / 60	60 / 60	60 / 60	60 / 60
				Outdoor	Cooling/Heating		70 / 70	71 / 71	73 / 73	73 / 73	70 / 70
Sound pressure level*1			Indoor*2		Cooling (P-Hi/Hi/Me/Lo)		46 / 38 / 36 / 31	47 / 41 / 37 / 32	47 / 41 / 37 / 32	46 / 38 / 36 / 31	46 / 38 / 36 / 31
				Outdoor	Heating (P-Hi/Hi/Me/Lo)		46 / 38 / 36 / 31	47 / 41 / 37 / 32	47 / 41 / 37 / 32	46 / 38 / 36 / 31	46 / 38 / 36 / 31
			Indoor*2		Cooling/Heating		54 / 56	55 / 57	57 / 59	57 / 59	54 / 56
				Outdoor	Cooling (P-Hi/Hi/Me/Lo)		13 / 10 / 9 / 7	20 / 16 / 13 / 10	20 / 16 / 13 / 10	13 / 10 / 9 / 7	13 / 10 / 9 / 7
			Outdoor		Heating (P-Hi/Hi/Me/Lo)		13 / 10 / 9 / 7	20 / 16 / 13 / 10	20 / 16 / 13 / 10	13 / 10 / 9 / 7	13 / 10 / 9 / 7
				Indoor	Cooling/Heating		75 / 73	75 / 73	75 / 73	75 / 73	75 / 73
Exterior dimensions			Indoor		HeightxWidthxDepth	mm	210 x 1,070 x 690		210 x 1,320 x 690		210 x 1,070 x 690
			Outdoor			845 x 970 x 370					
Net weight			Indoor		kg	28		33		28	
			Outdoor			80			82		
Ref.piping size			Liquid/Gas		ømm	9.52(3/8") / 15.88(5/8")					
Refrigerant line (one way) length					m	Max. 50					
Vertical height differences			Outdoor is higher/lower		m	Max.50 / Max.15					
Outdoor operating temperature range			Cooling		°C	-15~50*3					
			Heating			-20~20					
Air filter, Q'ty			Pocket plastic net x 2(Washable)								
Remote control (option)			wired:RC-EX3A, RC-E5, RCH-E3 wireless:RCN-E-E3								

SPECIFICATIONS

The values are for simultaneous Multi operation.

Set model name		Micro Inverter				
		FDE140VSAPVG	FDE200VSAPVG	FDE250VSAPVG	FDE140VSATVG	FDE200VSATVG
		Twin			Triple	
Indoor unit		FDE71VG x 2	FDE100VG x 2	FDE125VG x 2	FDE50VG x 3	FDE71VG x 3
Outdoor unit		FDC140VSA	FDC200VSA	FDC250VSA	FDC140VSA	FDC200VSA
Power source		3 Phase 380-415V, 50Hz / 380V, 60Hz				
Nominal cooling capacity (Min~Max)	kW	13.6 (5.0 ~ 14.5)	19.0 (5.2 ~ 22.4)	24.0 (6.9 ~ 28.0)	13.6 (5.0 ~ 14.5)	19.0 (5.2 ~ 22.4)
Nominal heating capacity (Min~Max)	kW	15.5 (4.0 ~ 16.5)	22.4 (3.3 ~ 25.0)	27.0 (5.5 ~ 31.5)	15.5 (4.0 ~ 16.5)	22.4 (3.3 ~ 25.0)
Power consumption	Cooling/Heating	4.74 / 4.21	6.34 / 6.10	8.52 / 7.54	4.74 / 4.21	6.33 / 5.94
EER/COP	Cooling/Heating	2.87 / 3.68	3.00 / 3.67	2.82 / 3.58	2.87 / 3.68	3.00 / 3.77
Inrush current		5	5	5	5	5
Max. current		15	20	21	15	20
Sound power level*1	Indoor*2	Cooling/Heating	60 / 60	64 / 64	64 / 64	60 / 60
	Outdoor	Cooling/Heating	73 / 73	72 / 74	73 / 75	73 / 73
Sound pressure level*1	Indoor*2	Cooling (P-Hi/Hi/Me/Lo)	47 / 41 / 37 / 32	48 / 43 / 38 / 44	48 / 45 / 40 / 35	46 / 38 / 36 / 31
	Outdoor	Cooling/Heating	57 / 59	58 / 59	59 / 62	57 / 59
Air flow	Indoor*2	Cooling (P-Hi/Hi/Me/Lo)	20 / 16 / 13 / 10	32 / 26 / 21 / 16.5	32 / 29 / 23 / 17	13 / 10 / 9 / 7
	Outdoor	Cooling/Heating	75 / 73	135 / 135	143 / 151	75 / 73
Exterior dimensions	Indoor	HeightxWidthxDepth	210 x 1,320 x 690	250 x 1,620 x 690	210 x 1,070 x 690	210 x 1,320 x 690
	Outdoor		845 x 970 x 370	1,300 x 970 x 370	1,505 x 970 x 370	845 x 970 x 370
Net weight	Indoor		33	43	28	33
	Outdoor		82	115	143	82
Ref.piping size	Liquid/Gas	ømm	9.52(3/8") / 15.88(5/8")	9.52(3/8") / 22.22(7/8")	12.7(1/2") / 22.22(7/8")	9.52(3/8") / 15.88(5/8")
Refrigerant line (one way) length		m	Max.50	Max.70	Max.50	Max.70
Vertical height differences	Outdoor is higher/lower	m	Max.50 / Max.15	Max.30 / Max.15	Max.50 / Max.15	Max.30 / Max.15
Outdoor operating temperature range	Cooling	°C	-15~50*3			
	Heating		-20~20	-15~20	-20~20	-15~20
Air filter, Q'ty			Pocket plastic net x 2(Washable)			
Remote control (option)			wired:RC-EX3A, RC-E5, RCH-E3 wireless:RCN-E-E3			

The values are for simultaneous Multi operation.

Set model name		Micro Inverter	
		FDE200VSADVG	FDE250VSADVG
		Double Twin	
Indoor unit		FDE50VG x 4	FDE60VG x 4
Outdoor unit		FDC200VSA	FDC250VSA
Power source		3 Phase 380-415V, 50Hz / 380V, 60Hz	
Nominal cooling capacity (Min~Max)	kW	19.0 (5.2 ~ 22.4)	24.0 (6.9 ~ 28.0)
Nominal heating capacity (Min~Max)	kW	22.4 (3.3 ~ 25.0)	27.0 (5.5 ~ 31.5)
Power consumption	Cooling/Heating	6.90 / 7.10	8.00 / 7.02
EER/COP	Cooling/Heating	2.75 / 3.15	3.00 / 3.85
Inrush current		5	5
Max. current		20	21
Sound power level*1	Indoor*2	Cooling/Heating	60 / 60
	Outdoor	Cooling/Heating	72 / 74
Sound pressure level*1	Indoor*2	Cooling (P-Hi/Hi/Me/Lo)	46 / 38 / 36 / 31
	Outdoor	Cooling/Heating	58 / 59
Air flow	Indoor*2	Cooling (P-Hi/Hi/Me/Lo)	13 / 10 / 9 / 7
	Outdoor	Cooling/Heating	135 / 135
Exterior dimensions	Indoor	HeightxWidthxDepth	210 x 1,070 x 690
	Outdoor		1,300 x 970 x 370
Net weight	Indoor		28
	Outdoor		115
Ref.piping size	Liquid/Gas	ømm	9.52(3/8") / 22.22(7/8")
Refrigerant line (one way) length		m	Max.70
Vertical height differences	Outdoor is higher/lower	m	Max.30 / Max.15
Outdoor operating temperature range	Cooling	°C	-15~50*3
	Heating		-15~20
Air filter, Q'ty			Pocket plastic net x 2(Washable)
Remote control (option)			wired:RC-EX3A, RC-E5, RCH-E3 wireless:RCN-E-E3

NOTES:

The data are measured under the following conditions(ISO-T1).
 Cooling:Indoor temp. of 27°CDB, 19°CWB, and outdoor temp. of 35°CDB. Heating:Indoor temp. of 20°CDB, and outdoor temp. of 7°CDB, 6°CWB.
 *1 : Indicates the value in an anechoic chamber. During operation these values are somewhat higher due to ambient conditions.
 *2 : The values are for one indoor unit operation. (Multi system only)
 *3 : If a cooling operation is conducted when the outdoor air temperature is -5°C or lower, the outdoor unit should be installed at a place where it is not influenced by natural wind. If wind blows, the low pressure will drop and compressor frequency will increase, this will cause the capacity to drop and may cause the unit to break down.

SPECIFICATIONS

		Standard Inverter		
Set model name		FDE71VNPVG	FDE90VNP1VG	FDE100VNP1VG
Indoor unit		FDE71VG	FDE100VG	FDE100VG
Outdoor unit		FDC71VNP	FDC90VNP1	FDC100VNP
Power source		1 Phase 220-240V, 50Hz / 220V, 60Hz		
Nominal cooling capacity (Min~Max)		kW 7.1 (1.4 ~ 7.1)	9.0 (1.9 ~ 9.0)	10.0 (2.8 ~ 11.2)
Nominal heating capacity (Min~Max)		kW 7.1 (1.0 ~ 7.1)	9.0 (1.5 ~ 9.0)	11.2 (2.5 ~ 12.5)
Power consumption	Cooling/Heating	kW 2.50 / 1.96	2.75 / 2.22	2.66 / 2.94
	EER/COP	Cooling/Heating 2.84 / 3.62	3.27 / 4.05	3.76 / 3.81
Inrush current		A 5	5	5
Max. current		14.5	18.0	21.0
Sound power level*1	Indoor	Cooling/Heating 60 / 60	64 / 64	64 / 64
	Outdoor	Cooling/Heating 67 / 67	69 / 69	70 / 70
Sound pressure level*1	Indoor	Cooling (P-Hi/Hi/Me/Lo)	dB(A) 47 / 41 / 37 / 32	48 / 43 / 38 / 34
		Heating (P-Hi/Hi/Me/Lo)	47 / 41 / 37 / 32	48 / 43 / 38 / 34
	Outdoor	Cooling/Heating 54 / 54	57 / 55	57 / 61
		Air flow	Indoor	Cooling (P-Hi/Hi/Me/Lo)
		Heating (P-Hi/Hi/Me/Lo)	20 / 16 / 13 / 10	32 / 26 / 21 / 16.5
		Outdoor	Cooling/Heating 36 / 36	63 / 49.5
Exterior dimensions	Indoor	HeightxWidthxDepth	mm 210 x 1,320 x 690	
	Outdoor	640 x 800(+71) x 290	750 x 880(+88) x 340	845 x 970 x 370
Net weight	Indoor		kg 33	
	Outdoor		45	57
Ref.piping size	Liquid/Gas	ømm 6.35(1/4") / 12.7(1/2")	6.35(1/4") / 15.88(5/8")	9.52(3/8") / 15.88(5/8")
Refrigerant line (one way) length		m Max.30		
Vertical height differences		Outdoor is higher/lower	Max.20 / Max.20	
Outdoor operating temperature range	Cooling	°C -15~46*3		
	Heating	-15~20		
Air filter, Q'ty		Pocket Plastic net x2(Washable)		
Remote control (option)		wired:RC-EX3A, RC-E5, RCH-E3 wireless:RCN-E-E3		

FLOOR STANDING FDF



*Not all functions are available with all remote control options.

Wireless remote control (Option)



RCN-KIT4-E2



FDF 71/100/125/140

Point 1 Wide and powerful air flow

Wide and powerful air flow increase your comfort, realizing high efficiency in combination with our highly advanced outdoor units.



Point 2 Easy Transportation and Installation workability

Piping and drain hose connection can be selected out of 4-directions and the selection makes installation workability more effective. Due to slim design (Depth: 320mm), easy transportation and installation are realized.

Easy Maintenance

The surface of heat exchanger can be appeared only removing the front panel. Easy cleaning of heat exchanger is possible.



OUTDOOR UNIT

FDC	Hyper Inverter		Micro Inverter		
	71VNX	100~140VN(S)X	100~140VN(S)A	200VSA	250VSA
model					
Chargeless	15m	30m	30m		
Height x Width x Depth (mm)	750 x 880(+71) x 340	1,300 x 970 x 370	845 x 970 x 370	1,300 x 970 x 370	1,505 x 970 x 370

FDC	Standard Inverter		
	71VNP	90VNP1	100VNP
model			
Chargeless	8m		15m
Height x Width x Depth (mm)	640 x 800(+71) x 290	750 x 880(+88) x 340	845 x 970 x 370

DIMENSIONS(Unit:mm)

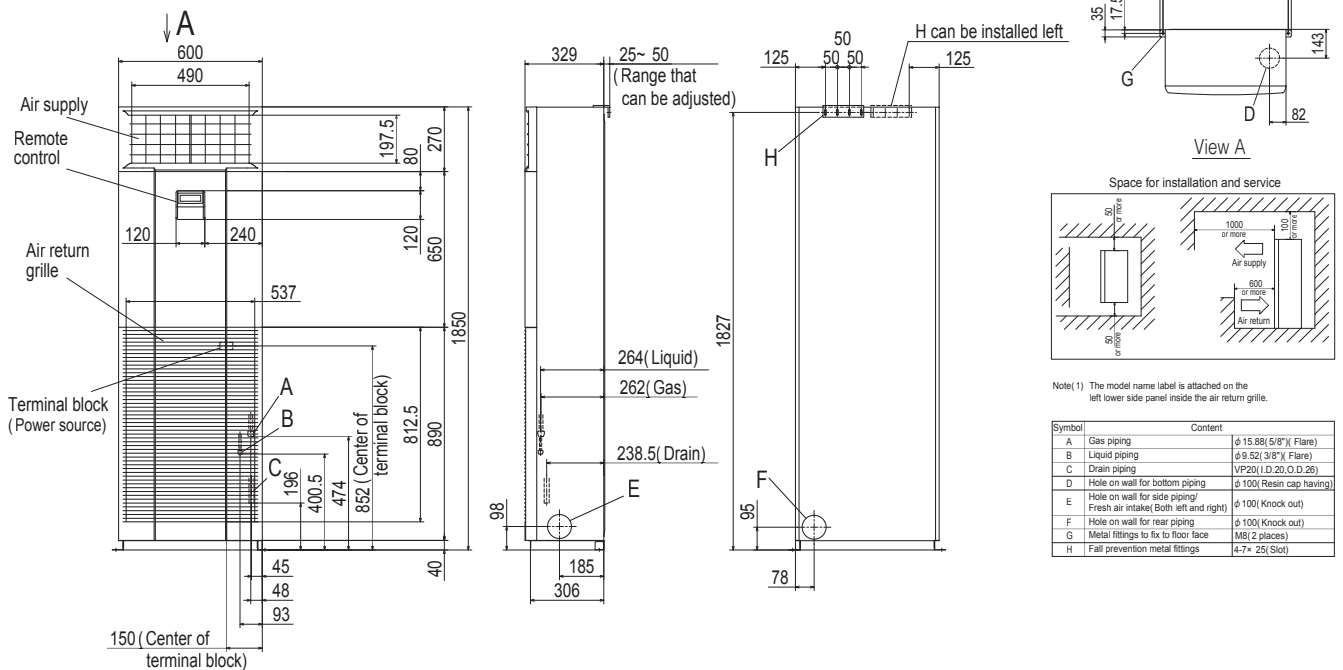

SPECIFICATIONS

		Hyper Inverter						
Set model name		PDF71VNXVD1	PDF100VNXVD2	PDF125VNXVD	PDF140VNXVD	PDF100VSXVD2	PDF125VSXVD	PDF140VSXVD
Indoor unit		PDF71VD1	PDF100VD2	PDF125VD	PDF140VD	PDF100VD2	PDF125VD	PDF140VD
Outdoor unit		FDC71VNX	FDC100VNX	FDC125VNX	FDC140VNX	FDC100VSX	FDC125VSX	FDC140VSX
Power source		1 Phase 220-240V, 50Hz / 220V, 60Hz				3 Phase 380-415V, 50Hz / 380V, 60Hz		
Nominal cooling capacity (Min~Max)		kW 7.1 (3.2 ~ 8.0)	10.0 (4.0 ~ 11.2)	12.5 (5.0 ~ 14.0)	14.0 (5.0 ~ 16.0)	10.0 (4.0 ~ 11.2)	12.5 (5.0 ~ 14.0)	14.0 (5.0 ~ 16.0)
Nominal heating capacity (Min~Max)		kW 8.0 (3.6 ~ 9.0)	11.2 (4.0 ~ 12.5)	14.0 (4.0 ~ 17.0)	16.0 (4.0 ~ 18.0)	11.2 (4.0 ~ 16.0)	14.0 (4.0 ~ 18.0)	16.0 (4.0 ~ 20.0)
Power consumption		Cooling/Heating kW 2.21 / 2.21	2.83 / 3.04	3.89 / 3.88	4.65 / 4.69	2.83 / 3.04	3.89 / 3.88	4.65 / 4.69
EER/COP		Cooling/Heating 3.21 / 3.62	3.53 / 3.68	3.21 / 3.61	3.01 / 3.41	3.53 / 3.68	3.21 / 3.61	3.01 / 3.41
Inrush current		A 5	5	5	5	5	5	5
Max. current		17	24	26	26	15	15	15
Sound power level*1	Indoor	Cooling/Heating 61 / 61	65 / 65	73 / 73	73 / 73	65 / 65	73 / 73	73 / 73
	Outdoor	Cooling/Heating 66 / 66	70 / 70	70 / 70	72 / 72	70 / 70	70 / 70	72 / 72
Sound pressure level*1	Indoor	Cooling (P-Hi/Hi/Me/Lo) 42 / 39 / 35 / 33	54 / 50 / 48 / 44	54 / 50 / 48 / 44	54 / 50 / 48 / 44	54 / 50 / 48 / 44	54 / 50 / 48 / 44	54 / 50 / 48 / 44
	Outdoor	Cooling/Heating 51 / 48	48 / 50	48 / 50	49 / 52	48 / 50	48 / 50	49 / 52
Air flow	Indoor	Cooling (P-Hi/Hi/Me/Lo) 20 / 18 / 16 / 14	29 / 26 / 23 / 19	29 / 26 / 23 / 19	29 / 26 / 23 / 19	29 / 26 / 23 / 19	29 / 26 / 23 / 19	29 / 26 / 23 / 19
	Outdoor	Cooling/Heating 60 / 50	100 / 100	100 / 100	100 / 100	100 / 100	100 / 100	100 / 100
Exterior dimensions	Indoor	1,850 x 600 x 320						
	Outdoor	750 x 880(+88) x 340						
Net weight	Indoor	49				52		
	Outdoor	60				105		
Ref.piping size		Liquid/Gas ϕ mm	9.52(3/8") / 15.88(5/8")					
Refrigerant line (one way) length		m	Max.50		Max.100			
Vertical height differences		Outdoor is higher/lower	Max.30 / Max.15					
Outdoor operating temperature range		Cooling/Heating $^{\circ}$ C	-15~43*2					
Air filter, Q'ty		Plastic net x 1(washable)						
Remote control		wired:RC-E5 (installed) wireless:RCN-KIT4-E2 (option)						

NOTES:

The data are measured under the following conditions(ISO-T1).
 Cooling:Indoor temp. of 27°CDB, 19°CWB, and outdoor temp. of 35°CDB. Heating:Indoor temp. of 20°CDB, and outdoor temp. of 7°CDB, 6°CWB.
 *1 : Indicates the value in an anechoic chamber. During operation these values are somewhat higher due to ambient conditions.
 *2 : If a cooling operation is conducted when the outdoor air temperature is -5°C or lower, the outdoor unit should be installed at a place where it is not influenced by natural wind. If wind blows, the low pressure will drop and compressor frequency will increase, this will cause the capacity to drop and may cause the unit to break down.

SPECIFICATIONS

The values are for simultaneous Multi operation.

				<i>Hyper Inverter</i>		
Set model name		FDF140VNX PVD1		FDF140VXS PVD1		
		Twin				
Indoor unit		FDF71VD1 x 2		FDF71VD1 x 2		
Outdoor unit		FDC140VNX		FDC140VXS		
Power source		1 Phase 220-240V, 50Hz / 220V, 60Hz		3 Phase 380-415V, 50Hz / 380V 60Hz		
Nominal cooling capacity (Min~Max)	kW	14.0 (5.0 ~ 16.0)		14.0 (5.0 ~ 16.0)		
Nominal heating capacity (Min~Max)	kW	16.0 (4.0 ~ 18.0)		16.0 (4.0 ~ 20.0)		
Power consumption	Cooling/Heating	4.83 / 4.97		4.83/ 4.97		
EER/COP	Cooling/Heating	2.90 / 3.22		2.90 / 3.22		
Inrush current	A	5		5		
Max. current		26		15		
Sound power level*1	Indoor*2	Cooling/Heating		61 / 61		
	Outdoor	Cooling/Heating		72 / 72		
Sound pressure level*1	Indoor*2	dB(A)	Cooling (P-Hi/Hi/Me/Lo)	42 / 39 / 35 / 33		
			Heating (P-Hi/Hi/Me/Lo)	42 / 39 / 35 / 33		
	Outdoor	Cooling/Heating	49 / 52		49 / 52	
		Air flow	Indoor*2	Cooling (P-Hi/Hi/Me/Lo)	18 / 16 / 14 / 12	
		Heating (P-Hi/Hi/Me/Lo)	18 / 16 / 14 / 12			
	Outdoor	Cooling/Heating	100 / 100		100 / 100	
Exterior dimensions	Indoor	HeightxWidthxDepth	mm	1,850 x 600 x 320		
	Outdoor			1,300 x 970 x 370		
Net weight	Indoor		kg	49		
	Outdoor			105		
Ref.piping size	Liquid/Gas		ømm	9.52(3/8") / 15.88(5/8")		
Refrigerant line (one way) length		m				Max.100
Vertical height differences		Outdoor is higher/lower		m		Max.30 / Max.15
Outdoor operating temperature range	Cooling	°C				-15~43*3
	Heating					-20~20
Air filter, Q'ty						Plastic net x 1(washable)
Remote control						wired:RC-E5 (installed) wireless:RCN-KIT4-E2 (option)

		<i>Micro Inverter</i>						
Set model name		FDF100VNAVD2	FDF125VNAVD	FDF140VNAVD	FDF100VSAVD2	FDF125VSAVD	FDF140VSAVD	
Indoor unit		FDF100VD2	FDF125VD	FDF140VD	FDF100VD2	FDF125VD	FDF140VD	
Outdoor unit		FDC100VNA	FDC125VNA	FDC140VNA	FDC100VSA	FDC125VSA	FDC140VSA	
Power source		1 Phase 220-240V, 50Hz / 220V, 60Hz			3 Phase 380-415V, 50Hz / 380V, 60Hz			
Nominal cooling capacity (Min~Max)	kW	10.0 (4.0 ~ 11.2)	12.5 (5.0 ~ 13.0)	13.0 (5.0 ~ 13.0)	10.0 (4.0 ~ 11.2)	12.5 (5.0 ~ 14.0)	13.6 (5.0 ~ 14.5)	
Nominal heating capacity (Min~Max)	kW	11.2 (4.0 ~ 12.5)	14.0 (4.0 ~ 16.0)	15.5 (4.0 ~ 16.5)	11.2 (4.0 ~ 12.5)	14.0 (4.0 ~ 16.0)	15.5 (4.0 ~ 16.5)	
Power consumption	Cooling/Heating	3.12 / 2.94	4.65 / 4.14	5.02 / 4.98	3.12 / 2.94	4.65 / 4.14	5.42 / 4.98	
EER/COP	Cooling/Heating	3.21 / 3.81	2.69 / 3.38	2.59 / 3.11	3.21 / 3.81	2.69 / 3.38	2.51 / 3.11	
Inrush current	A	5	5	5	5	5	5	
Max. current		24	24	24	15	15	15	
Sound power level*1	Indoor	Cooling/Heating		65 / 65		73 / 73		
	Outdoor	Cooling/Heating		70 / 70		71 / 71		
Sound pressure level*1	Indoor	dB(A)	Cooling (P-Hi/Hi/Me/Lo)	54 / 50 / 48 / 44		54 / 50 / 48 / 44		
			Heating (P-Hi/Hi/Me/Lo)	54 / 50 / 48 / 44		54 / 50 / 48 / 44		
	Outdoor	Cooling/Heating	54 / 56		55 / 57		57 / 59	
		Air flow	Indoor	Cooling (P-Hi/Hi/Me/Lo)	29 / 26 / 23 / 19		29 / 26 / 23 / 19	
		Heating (P-Hi/Hi/Me/Lo)	29 / 26 / 23 / 19		29 / 26 / 23 / 19			
	Outdoor	Cooling/Heating	75 / 73		75 / 73		75 / 73	
Exterior dimensions	Indoor	HeightxWidthxDepth	mm	1,850 x 600 x 320				
	Outdoor			845 x 970 x 370				
Net weight	Indoor		kg	52				
	Outdoor			80	82			
Ref.piping size	Liquid/Gas		ømm	9.52(3/8") / 15.88(5/8")				
Refrigerant line (one way) length		m				Max.50		
Vertical height differences		Outdoor is higher/lower		m		Max.50 / Max.15		
Outdoor operating temperature range	Cooling	°C				-15~50*3		
	Heating					-20~20		
Air filter, Q'ty						Plastic net x 1(Washable)		
Remote control						wired:RC-E5 (installed) wireless:RCN-KIT4-E2 (option)		

NOTES:

The data are measured under the following conditions(ISO-T1).
 Cooling:Indoor temp. of 27°CDB, 19°CWB, and outdoor temp. of 35°CDB. Heating:Indoor temp. of 20°CDB, and outdoor temp. of 7°CDB, 6°CWB.
 *1 : Indicates the value in an anechoic chamber. During operation these values are somewhat higher due to ambient conditions.
 *2 : The values are for one indoor unit operation. (Multi system only)
 *3 : If a cooling operation is conducted when the outdoor air temperature is -5°C or lower, the outdoor unit should be installed at a place where it is not influenced by natural wind. If wind blows, the low pressure will drop and compressor frequency will increase, this will cause the capacity to drop and may cause the unit to break down.

SPECIFICATIONS

The values are for simultaneous Multi operation.

Set model name		Micro Inverter									
		FDf140VNAPVD1	FDf140VSAPVD1	FDf200VSAPVD2	FDf250VSAPVD						
Indoor unit		FDf71VD1 x 2		FDf71VD1 x 2		FDf100VD2 x 2		FDf125VD x 2			
Outdoor unit		FDc140VNA		FDc140VSA		FDc200VSA		FDc250VSA			
Power source		1 Phase 220-240V, 50Hz / 220V, 60Hz		Twin		3 Phase 380-415V, 50Hz / 380V, 60Hz					
Nominal cooling capacity (Min~Max)		kW 13.6 (5.0 ~ 14.5)		13.6 (5.0 ~ 14.5)		19.0 (5.2 ~ 22.4)		24.0 (6.9 ~ 28.0)			
Nominal heating capacity (Min~Max)		kW 15.5 (4.0 ~ 16.5)		15.5 (4.0 ~ 16.5)		22.4 (3.3 ~ 25.0)		27.0 (5.5 ~ 31.5)			
Power consumption		Cooling/Heating kW 5.15 / 4.35		5.15 / 4.35		6.74 / 6.42		9.15 / 8.49			
EER/COP		Cooling/Heating 2.64 / 3.56		2.64 / 3.56		2.82 / 3.49		2.62 / 3.18			
Inrush current		A 5		5		5		5			
Max. current		24		15		20		21			
Sound power level*1	Indoor*2	Cooling/Heating 61 / 61		61 / 61		65 / 65		73 / 73			
	Outdoor	Cooling/Heating 73 / 73		73 / 73		72 / 74		73 / 75			
Sound pressure level*1	Indoor*2	Cooling (P-Hi/Hi/Me/Lo)	dB(A) 42 / 39 / 35 / 33		42 / 39 / 35 / 33		54 / 50 / 48 / 44		54 / 50 / 48 / 44		
			Heating (P-Hi/Hi/Me/Lo)	42 / 39 / 35 / 33		42 / 39 / 35 / 33		54 / 50 / 48 / 44		54 / 50 / 48 / 44	
	Outdoor	Cooling/Heating 57 / 59		57 / 59		58 / 59		59 / 62			
		Air flow		Indoor*2		Cooling (P-Hi/Hi/Me/Lo)		m³/min 18 / 16 / 14 / 12		18 / 16 / 14 / 12	
		Heating (P-Hi/Hi/Me/Lo)		18 / 16 / 14 / 12		29 / 26 / 23 / 19		29 / 26 / 23 / 19			
		Outdoor		Cooling/Heating 75 / 73		75 / 73		135 / 135		143 / 151	
Exterior dimensions		Indoor		HeightxWidthxDepth mm 1,850 x 600 x 320		Outdoor		845 x 970 x 370		1,300 x 970 x 370	
		Net weight		Indoor kg 49		Outdoor		52		143	
Ref.piping size		Liquid/Gas ømm 9.52(3/8") / 15.88(5/8")		80		82		115		143	
Refrigerant line (one way) length		m Max.50		Max.50		Max.70		Max.70		Max.15	
Vertical height differences		Outdoor is higher/lower m Max.50 / Max.15		Max.30 / Max.15		Max.30 / Max.15		Max.30 / Max.15		Max.15	
Outdoor operating temperature range		Cooling °C -15~50*3		Heating -20~20		-15~20		-15~20		-15~20	
Air filter, Q'ty						Plastic net x 1 (washable)					
Remote control						wired:RC-E5 (installed) wireless:RCN-KIT4-E2 (option)					

Set model name		Standard Inverter									
		FDf71VNPVD1	FDf90VNP1VD2	FDf100VNP1VD2							
Indoor unit		FDf71VD1		FDf100VD2							
Outdoor unit		FDc71VNP		FDc90VNP1							
Power source		1 Phase 220-240V, 50Hz / 220V, 60Hz									
Nominal cooling capacity (Min~Max)		kW 7.1 (1.4 ~ 7.1)		9.0 (1.9 ~ 9.0)							
Nominal heating capacity (Min~Max)		kW 7.1 (1.0 ~ 7.1)		9.0 (1.5 ~ 9.0)							
Power consumption		Cooling/Heating kW 2.67 / 2.04		2.81 / 2.25							
EER/COP		Cooling/Heating 2.66 / 3.48		3.20 / 4.00							
Inrush current		A 5		5							
Max. current		14.5		18.0							
Sound power level*1	Indoor	Cooling/Heating 61 / 61		65 / 65							
	Outdoor	Cooling/Heating 67 / 67		69 / 69							
Sound pressure level*1	Indoor	Cooling (P-Hi/Hi/Me/Lo)	dB(A) 42 / 39 / 35 / 33		54 / 50 / 48 / 44						
			Heating (P-Hi/Hi/Me/Lo)	42 / 39 / 35 / 33		54 / 50 / 48 / 44					
	Outdoor	Cooling/Heating 54 / 54		57 / 55		57 / 61					
		Air flow		Indoor*2		Cooling (P-Hi/Hi/Me/Lo)		m³/min 20 / 18 / 16 / 14		29 / 26 / 23 / 19	
		Heating (P-Hi/Hi/Me/Lo)		20 / 18 / 16 / 14		29 / 26 / 23 / 19		29 / 26 / 23 / 19			
		Outdoor		Cooling/Heating 36 / 36		63 / 49.5		75 / 79			
Exterior dimensions		Indoor		HeightxWidthxDepth mm 1,850 x 600 x 320		Outdoor		640 x 800(+71) x 290		750 x 880(+88) x 340	
		Net weight		Indoor kg 49		Outdoor		52		70	
Ref.piping size		Liquid/Gas ømm 6.35(1/4") / 12.7(1/2")		6.35(1/4") / 15.88(5/8")		9.52(3/8") / 15.88(5/8")		9.52(3/8") / 15.88(5/8")			
Refrigerant line (one way) length		m Max.23		Max.20 / Max.20		Max.30		Max.30			
Vertical height differences		Outdoor is higher/lower m Max.20 / Max.20		Max.20 / Max.20		Max.30		Max.30			
Outdoor operating temperature range		Cooling °C -15~46*3		Heating -15~20		-15~20		-15~20			
Air filter, Q'ty						Plastic net x1 (Washable)					
Remote control						wired:RC-E5 (installed) wireless:RCN-KIT4-E2 (option)					

CONTROL SYSTEMS

Remote Control line up

wired		indoor unit	remote control	wireless		indoor unit	remote control	indoor unit	remote control
			RC-EX3A			FDT	RCN-T-5AW-E2	FDE	RCN-E-E3
			RC-E5			FDTc	RCN-TC-5AW-E2	FDU,FDUM,PDF	RCN-KIT4-E2
			RCH-E3						

Wired remote control (option)

RC-EX3A

Easy touch and Easy view with full dot Liquid Crystal display

User friendly

- LCD panel with light tap operation introduced as the industry's first
- Simple interface with only three buttons

Easy view

- Big LCD with 3.8 inch full dot display
- Back light function
- Multi language display (12 languages)

Operation mode setting screen

The desired operation mode can be selected by simply tapping this button.

Setting temperature screen

You can select the temperature as desired by tapping \uparrow / \downarrow button.

Operation mode

- Cooling
- Fan
- Dry
- Heating
- Auto

Run / Stop

The highest capacity operation (Max 15 minutes)

- Increasing compressor speed
- Increasing air flow volume

Energy-saving operation

- Changes set temperature. At 28°C in cooling mode and 22°C in heating mode, 25°C in auto mode.
- Operation correction by outdoor temperature

Main functions

	Function name	Description
Economy & Timer	Energy-saving operation	Since the capacity is controlled automatically based on the outdoor temperature, energy can be saved without losing comfort.
	Sleep timer	Set the time period from start to stop of operation. The selectable range of setting time is from 30 to 240 minutes (at 10-minute intervals).
	Set temperature auto return	The temperature automatically returns to the previously set temperature.
	Set ON timer by hour	When the set time elapses, the air conditioner starts.
	Set OFF timer by hour	When the set time elapses, the air conditioner stops.
	Set ON timer by clock	The air conditioner starts at the set time.
	Set OFF timer by clock	The air conditioner stops at the set time.
	Weekly timer	On or Off timer can be set on a weekly basis.
	Peak-cut timer	Capacity control can be set by using peak cut function on RC-EX3A for better energy saving. Five-step capacity control is available.
	Home leave operation	When the unit is not used for a long period of time, the room temperature is maintained at a moderate level, avoiding extremely hot or cool temperatures.
Comfort	Big LCD & Touch screen panel	Large 3.8 inch screen has resulted in improved visibility and operability.
	Easy modification of Individual flap control	User can visually confirm and set the direction of louvers using the visual display on the remotecontroller.
	Automatic fan speed *1	The micro-computer automatically adjusts the airflow effectively to follow the changes of return air temperature.
	Temp increment setting	Temperature increment for the change of the set temp can be changed.
	Silent mode	Set the period of time to operate the Outdoor unit with prioritizing the quietness.
Convenience	Function switch *1	The function switch allows user to select and set two functions among seven available functions .
	Favorite setting *1	Operation mode, set temperature, fan speed and air flow direction automatically adjust to the programmed favorite setting.
	Adjusting Brightness of the operation lamp	The brightness of the background light can be adjusted by 10 stages.
	LCD contrast setting	This function allows user to adjust LCD display contrast.
	High power operation	High Power Mode increases the unit operating ability for 15 minutes to quickly adjust the room temperature to a comfortable level.
	Back light setting	This convenient function allows user to see controls under low light conditions.
	Administrator settings	This function only allows specific individuals to operate the unit.
	Setting temp range	Limited range of setting temperature in the heating or the cooling operation can be selected.
	External Input/Output Function	The external input/output of indoor unit by remote controller can set input/output based on user needs.
	Select the language	Set the language to be displayed on the remote control.
Service	USB connection (mini-B)	This function allows batch input of schedule timer settings and other settings involving a large amount of data.
	Error code display	This function allows user to check information displayed when abnormal function of the unit occurs.
	Operation data display	Displays various types of air conditioner operation data in real time.
	Contact company display	Address of the service contact is displayed.
	Filter sign	Announces the due time for cleaning of the air filter.
	Static pressure adjustment	Allows user to adjust duct static pressure using the remote control.
Backup Control	Allows for rotation control, fault backup control, and capacity backup control.	

*1 Cannot be used when a centralized control remote is connected.

Wired remote control (option)

RC-E5



The RC-E5 control enables extensive access to service and maintenance technical data combined with easy to use functions and a clear LCD display.

Weekly timer function as standard

RC-E5 provides (as a standard feature) a weekly timer, which allows one-week operation schedules to be registered. A user can specify up to four times a day to start/stop the air conditioner. (Temperature setting is also possible with the timer).

Timer operation

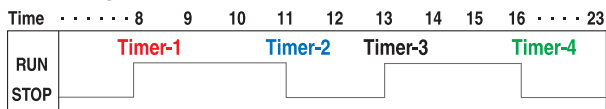

Run hour meters to facilitate maintenance checking

RC-E5 stores operation data when an anomaly occurs and indicates the error on the LCD. It also displays cumulative operation hours of the air conditioner and compressor since commissioning.

Room temperature controlled by the remote control sensor

The temperature sensor is housed in the top section of the remote control unit. This arrangement has improved the sensitivity of the remote control unit's sensor, which permits more finely controlled air conditioning.

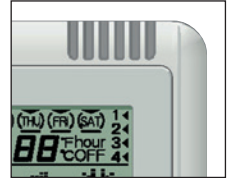

Changeable set temperature ranges

RC-E5 allows the upper and lower limits of a set temperature range to be specified separately.

By adjusting a set temperature range, you can ensure energy saving air conditioning by avoiding excessive cooling or heating.

Changeable range	
Upper limit	20~30°C(effective for heating operation)
Lower limit	18~26°C(effective for non-heating operation)

Simple remote control (option)

RCH-E3 (wired)



Considering specialized usage in hotel rooms, control buttons are limited only to minimum required functions such as ON/OFF, mode, temperature setting and fan speed. It is really simple and easy to use.

※ RCH-E3 is not applicable to the Individual flap control system.
When RCH-E3 is used, the fan has 3 speed settings (Hi-Me-Lo) only.

Up to 16 units

It can control up to 16 units individually, with pressing the AIR CON No. button.

AUTO restart

This function allows starting the air conditioner automatically when power supply is restored after power failure or by turning on the power switch.

Wireless remote control (option)

For wireless control simply insert the infrared receiver kit on a corner of the panel.

RCN-T-5AW-E2



RCN-TC-5AW-E2



RCN-KIT4-E2



RCN-E-E3



※ Wireless remote control is not applicable to the Individual flap control system.

Thermistor (option)

SC-THB-E3

In case sensor in the indoor units or the remote control sensor can not sense the room temperature correctly, or individual remote control in each room is not required but only sensor is required (as when center control system is in place), install SC-THB-E3 at proper place in the rooms.



CONTROL SYSTEMS

SUPERLINK-II

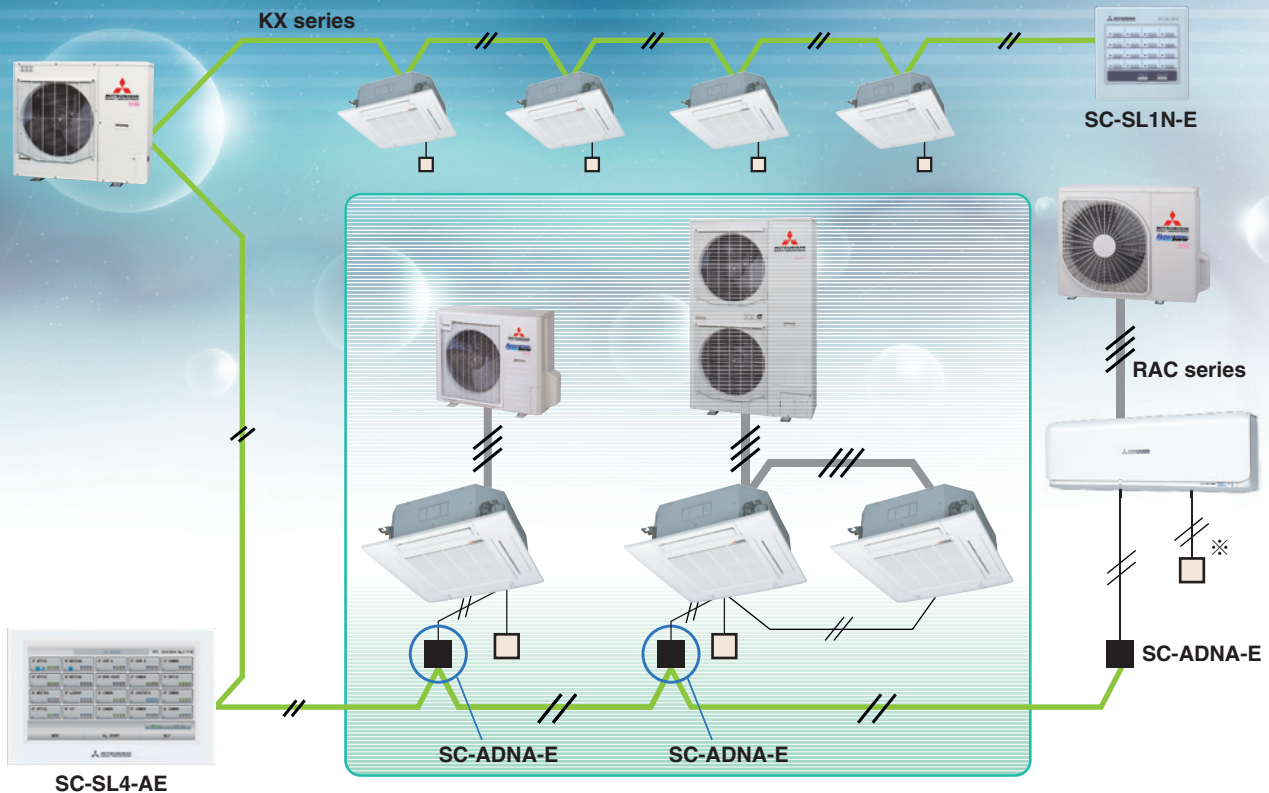

※SC-BIKN2-E is necessary to connect to wired remote controller.

Central Control

SC-SL1N-E



Start/stop control of up to 16 indoor units is possible either individually or collectively. With simple operations, you can effect centralized control.

SC-SL2NA-E

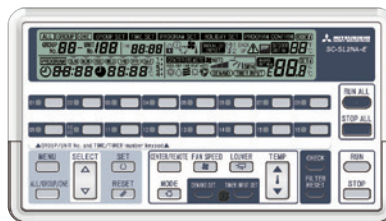

Centralized control of up to 64 indoor units. Including weekly timer function as standard.

SC-SL4-AE/BE



Easy operation realized with a large color LCD and touch panel. Up to 128 indoor units can be controlled, when SUPERLINK-II systems are connected.

Building Management Systems

SC-WBGW256* (Web gateway / BACnet gateway)

Users can manage up to 1024 units by connecting the four devices !!



Production by order

SC-WBGW256, up to 256 cells (some cells can have two or more indoor units and total number of indoor units can be up to 256 units) are controlled from the Internet Explorer and centrally from Building Management Systems.

SC-LGWNB* (LonWorks gateway)

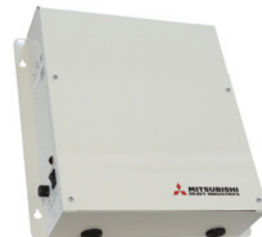

Production by order

Up to 96 indoor units can be integrated to a central control point via the building management system network.

*Additional engineering service is required. Please consult your dealer when using these system.

SUPERLINK E BOARD (SC-ADNA-E)

This board is used when conducting control of the single package (wired remote control unit) 1-type series using a network option (SC-SL1N-E, SC-SL2NA-E, etc).

(1) Functions

- (a) Transmits the settings from the network option to the indoor units.
- (b) Returns the priority indoor unit data in response to a data request from the network option.
- (c) Inspects the error status of connected indoor units and transmits the inspection codes to the network option.
- (d) A maximum of 16 units can be controlled (if in the same operation mode).

(2) Wiring connection diagram

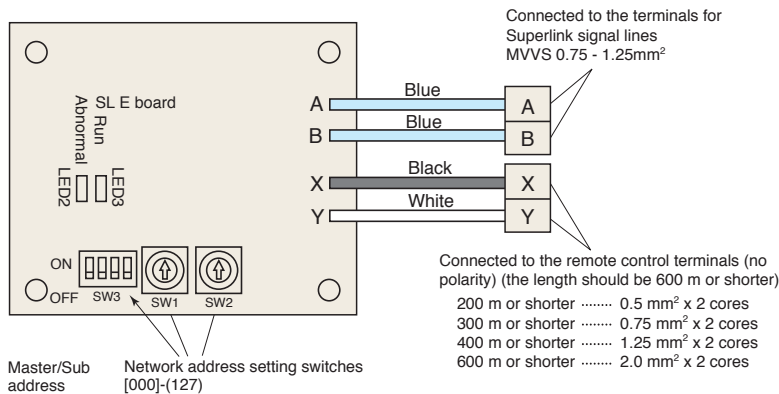

(3) Metal box dimension (unit:mm)

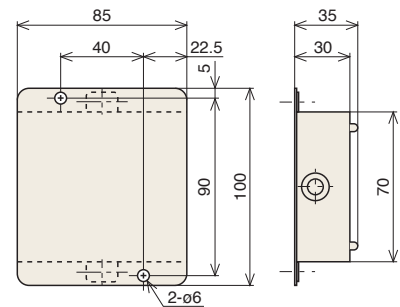

Basic Connections	Plural Controls by Multiple Remote Controls. Mixture of Multiple Units		
	<ul style="list-style-type: none"> • Transmit the information of plural "Master" units to the network. • Transmit the abnormalities of the "Slave" units to the network. ▶ Setting the plural "Master/Slave" units with the dip SW of the printed circuit board. ▶ Setting the "Master/Slave" remote controls with the dip SW of the remote control board. 		
<p>▶ Set up "000" to "127" using address switch on the SL E board.</p>		<h3>Without Remote Control</h3> <p>▶ Set the SL E board dip SW to "Master" SW3-1 ON. *The network option SL1N-E is not allowed (This will disturb switching of the operation mode)</p>	<h3>Wireless Kit</h3>

External switch connection CNT, CNTA

All indoor units are equipped with an additional connection point CnT to connect indoor units to an external ON/OFF switch; e.g. time clock, fire alarm, etc.



Remote surveillance system



Card key on-off

OUTDOOR UNIT DIMENSIONS (unit:mm)

SRC40ZSX-S, 50ZSX-S, 60ZSX-S

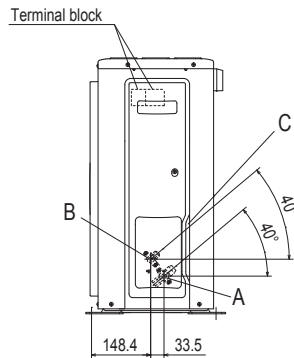
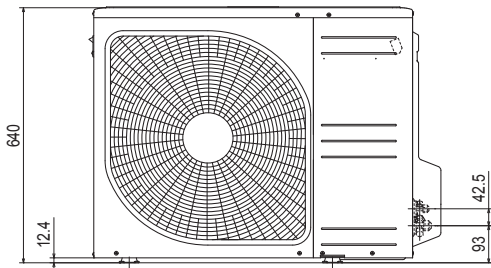
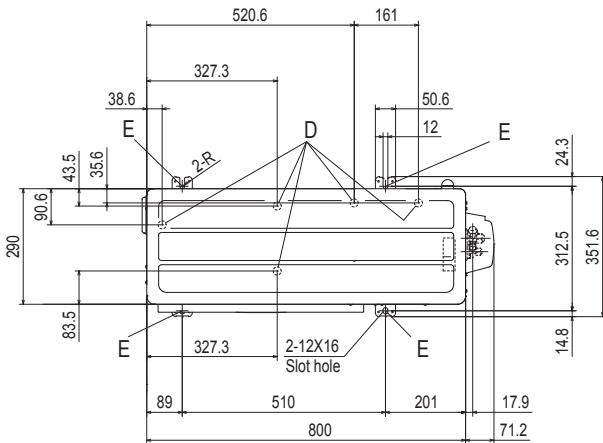

Symbol	Content	
A	Service valve connection (Gas side)	φ 12.7(1/2")(Flare)
B	Service valve connection (Liquid side)	φ 6.35(1/4")(Flare)
C	Pipe / cable draw-out hole	
D	Drain discharge hole	φ 20×5 places
E	Anchor bolt hole	M10-12×4 places

Notes

- (1) The unit must not be surrounded by walls on the four sides.
- (2) The unit must be fixed with anchor bolts. An anchor bolt must not protrude more than 15mm.
- (3) If the unit is installed in the location where there is a possibility of strong winds, place the unit such that the direction of air from the outlet gets perpendicular to the wind direction.
- (4) Leave 200mm or more space above the unit.
- (5) The wall height on the outlet side should be 1200mm or less.
- (6) The model name label is attached on the front side of the unit.

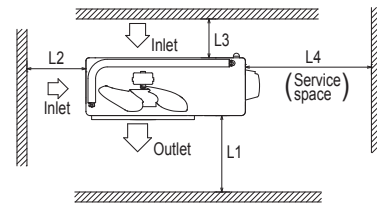

Minimum installation space

Examples installation Size	Examples installation			
	I	II	III	IV
L1	Open	280	280	180
L2	100	75	Open	Open
L3	100	80	80	80
L4	250	Open	250	Open

FDC71VNX

Symbol	Content	
A	Service valve connection (gas side)	φ 15.88 (5/8") (Flare)
B	Service valve connection (liquid side)	φ 9.52 (3/8") (Flare)
C	Pipe/cable draw-out hole	
D	Drain discharge hole	φ 20 × 3places
E	Anchor bolt hole	M10 × 4places

Notes

- (1) It must not be surrounded by walls on the four sides.
- (2) The unit must be fixed with anchor bolts. An anchor bolt must not protrude more than 15mm.
- (3) Where the unit is subject to strong winds, lay it in such a direction that the blower outlet faces perpendicularly to the dominant wind direction.
- (4) Leave 1m or more space above the unit.
- (5) A wall in front of the blower outlet must not exceed the units height.
- (6) The model name label is attached on the lower right corner of the front panel.

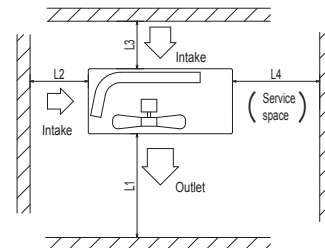
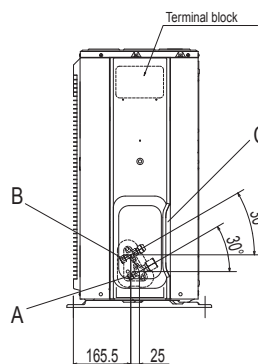
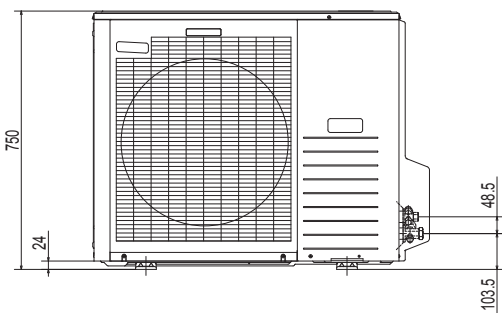
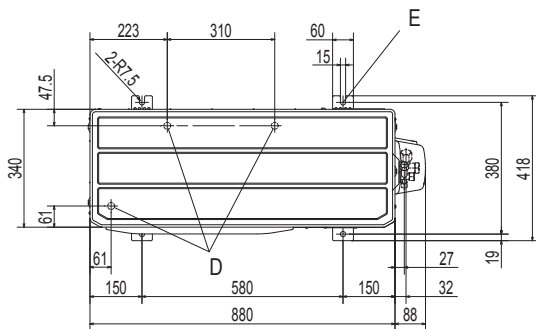

Minimum installation space

Examples of dimensions	Examples of dimensions		
	I	II	III
L1	Open	Open	500
L2	300	250	Open
L3	100	150	100
L4	250	250	250

**FDC100VNX, 100VSX, 125VNX, 125VSX,
140VNX, 140VSX**

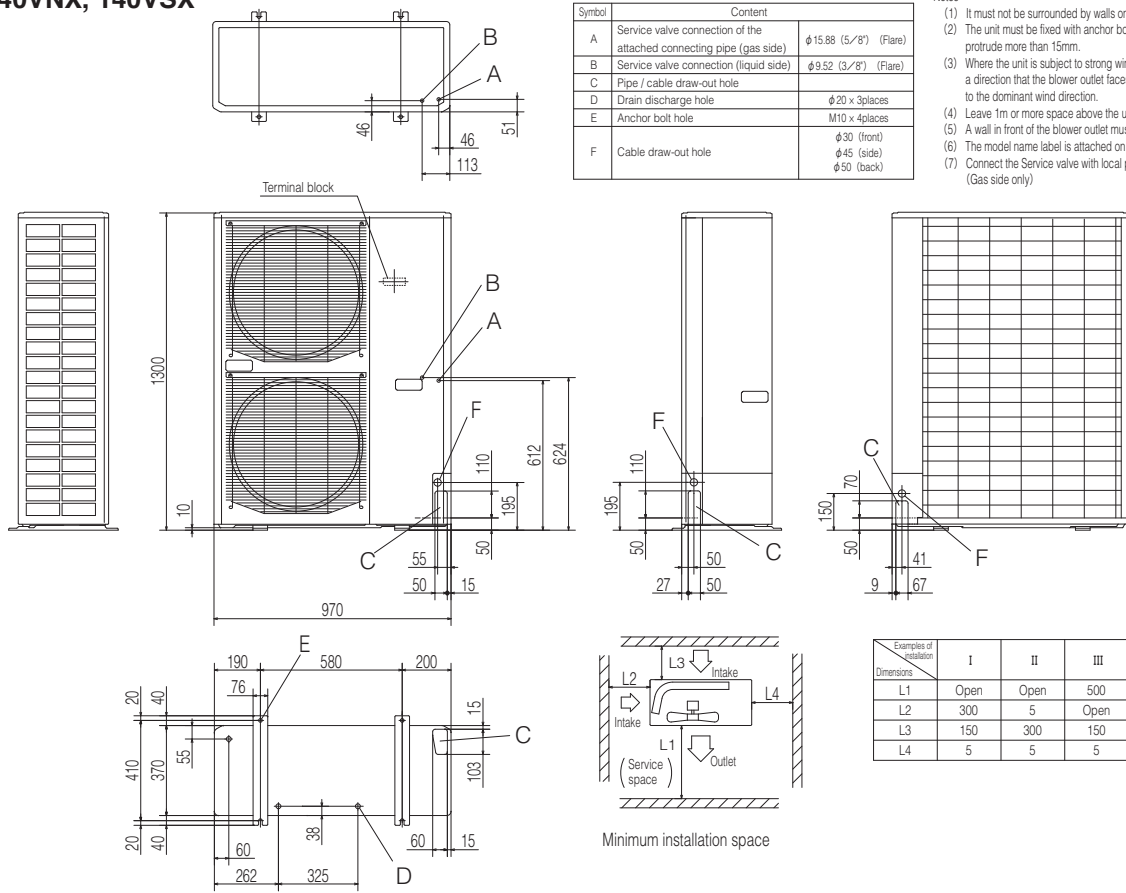

- Notes
- (1) It must not be surrounded by walls on the four sides.
 - (2) The unit must be fixed with anchor bolts. An anchor bolt must not protrude more than 15mm.
 - (3) Where the unit is subject to strong winds, lay it in such a direction that the blower outlet faces perpendicularly to the dominant wind direction.
 - (4) Leave 1m or more space above the unit.
 - (5) A wall in front of the blower outlet must not exceed the units height.
 - (6) The model name label is attached on the lower right corner of the front panel.
 - (7) Connect the Service valve with local pipe by using the pipe of the attachment. (Gas side only)

**FDC100VNA, 125VNA, 140VNA
100VSA, 125VSA, 140VSA**

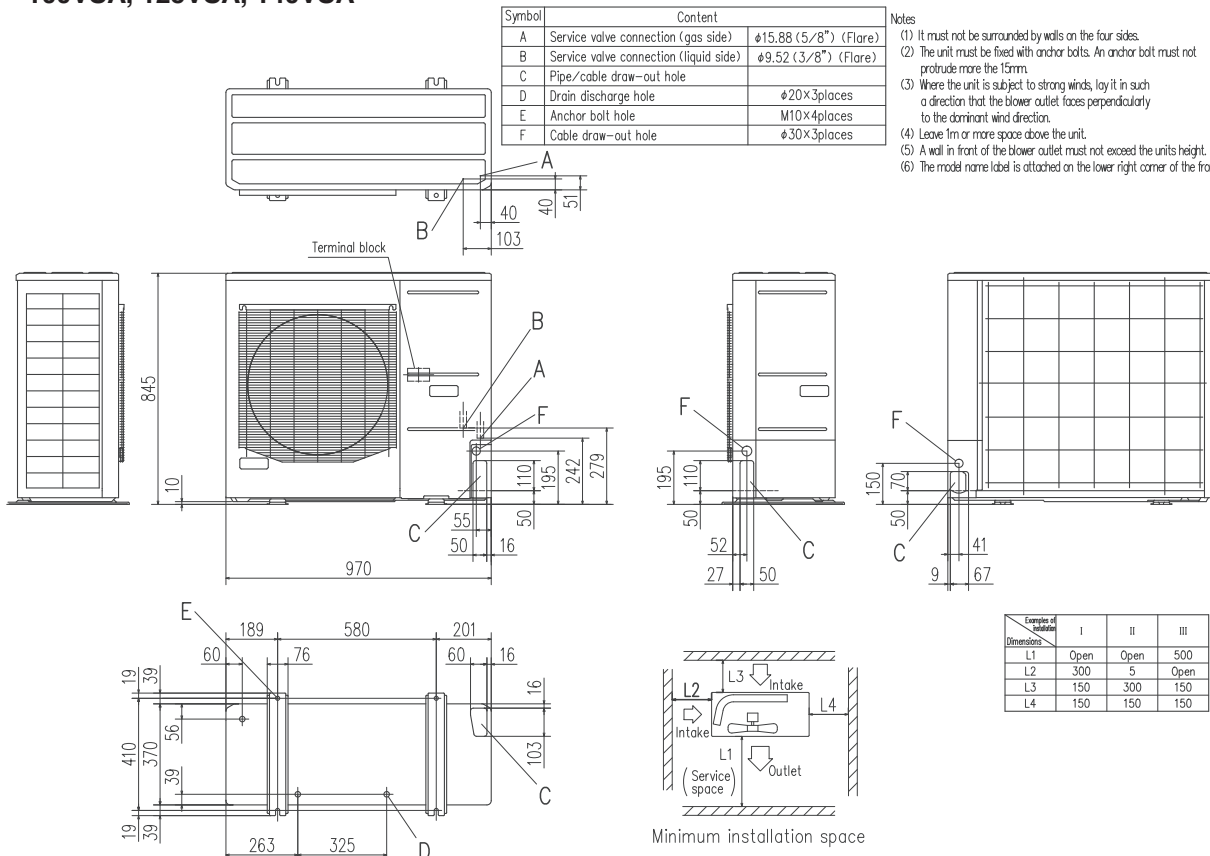

- Notes
- (1) It must not be surrounded by walls on the four sides.
 - (2) The unit must be fixed with anchor bolts. An anchor bolt must not protrude more than 15mm.
 - (3) Where the unit is subject to strong winds, lay it in such a direction that the blower outlet faces perpendicularly to the dominant wind direction.
 - (4) Leave 1m or more space above the unit.
 - (5) A wall in front of the blower outlet must not exceed the units height.
 - (6) The model name label is attached on the lower right corner of the front panel.

OUTDOOR UNIT DIMENSIONS (unit:mm)

FDC200VSA

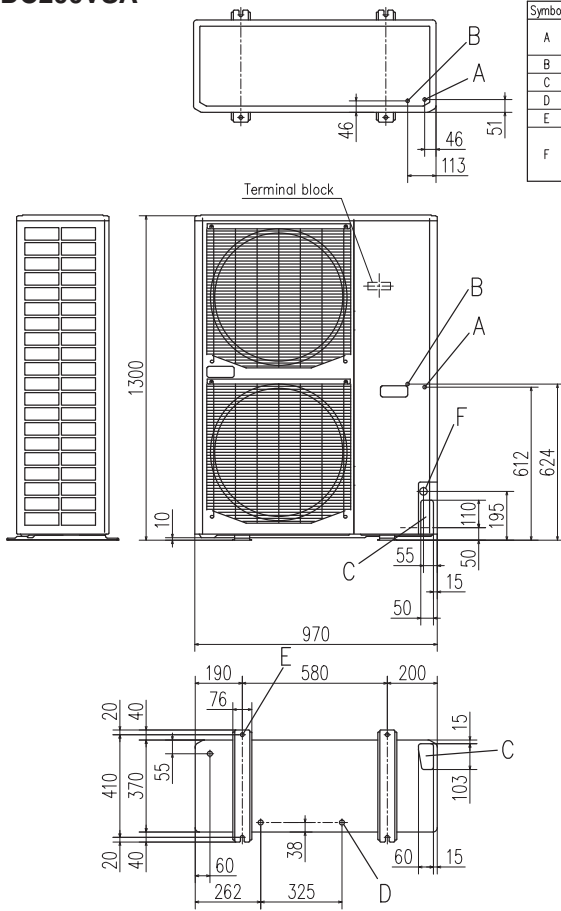

Symbol	Content	
A	Service valve connection of the attached connecting pipe (gas side)	φ19.05 (3/4") (Flare)
B	Service valve connection (liquid side)	φ9.52 (3/8") (Flare)
C	Pipe/cable draw-out hole	
D	Drain discharge hole	φ20×3places
E	Anchor bolt hole	M10×4places
F	Cable draw-out hole	φ30 (front) φ30 (side) φ30 (back)

Notes

- (1) It must not be surrounded by walls on the four sides.
- (2) The unit must be fixed with anchor bolts. An anchor bolt must not protrude more than 15mm.
- (3) Where the unit is subject to strong winds, lay it in such a direction that the blower outlet faces perpendicularly to the dominant wind direction.
- (4) Leave 1m or more space above the unit.
- (5) A wall in front of the blower outlet must not exceed the units height.
- (6) The model name label is attached on the lower right corner of the front panel.
- (7) Connect the Service valve with local pipe by using the pipe of the attachment. (Gas side only)
- (8) Regarding attaching the pipe of accessories, refer to an attached installation manual.

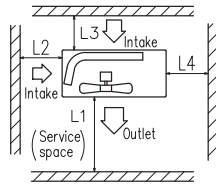
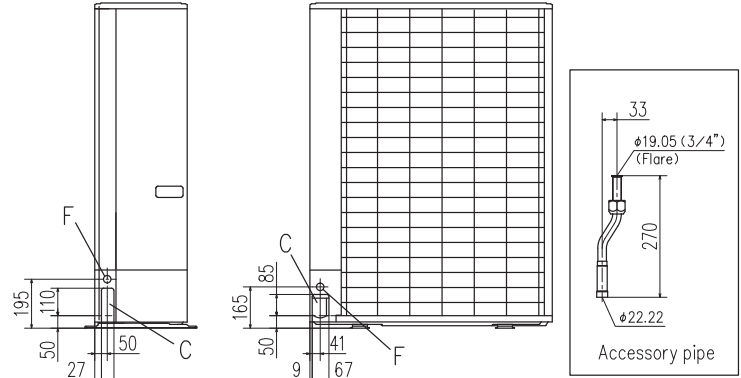

Minimum installation space

Unit:mm

Examples of installation				
Dimensions	I		III	
	L1	Open	Open	500
L2	300	5	Open	
L3	150	300	150	
L4	5	5	5	

FDC250VSA

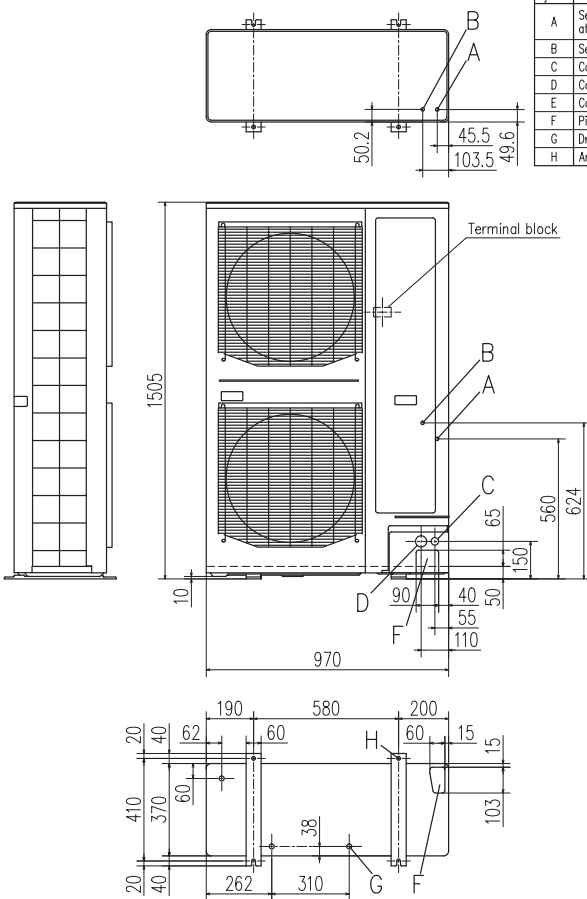

Symbol	Content	
A	Service valve connection of the attached connecting pipe (gas side)	φ19.05 (3/4") (Flare)
B	Service valve connection (liquid side)	φ12.7 (1/2") (Flare)
C	Cable draw-out hole (front side)	φ30×2places
D	Cable draw-out hole (front side)	φ45×2places
E	Cable draw-out hole (back)	φ50
F	Pipe/cable draw-out hole	4places
G	Drain discharge hole	φ20×3places
H	Anchor bolt hole	M10×4places

Notes

- (1) It must not be surrounded by walls on the four sides.
- (2) The unit must be fixed with anchor bolts. An anchor bolt must not protrude more than 15mm.
- (3) Where the unit is subject to strong winds, lay it in such a direction that the blower outlet faces perpendicularly to the dominant wind direction.
- (4) Leave 1m or more space above the unit.
- (5) A wall in front of the blower outlet must not exceed the units height.
- (6) The model name label is attached on the lower right corner of the front panel.
- (7) Connect the service valve with local pipe by using the pipe of the attachment. (Gas side only)
- (8) Regarding attaching the pipe of accessories, refer to an attached installation manual.

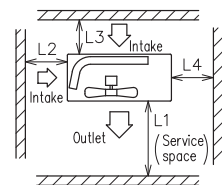
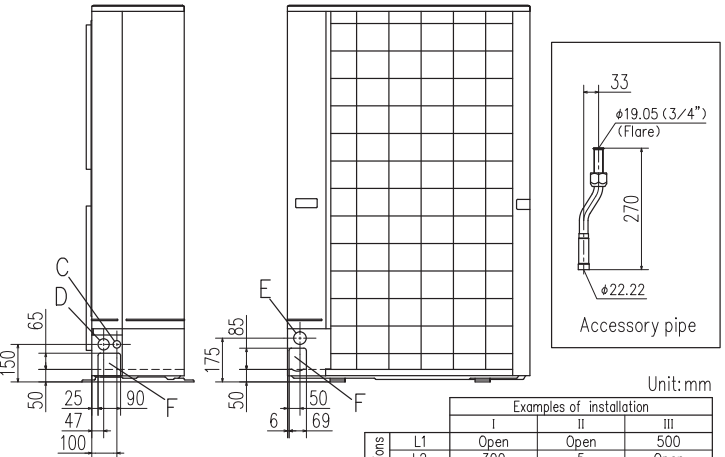

Minimum installation space

Unit:mm

Examples of installation				
Dimensions	I		III	
	L1	Open	Open	500
L2	300	5	Open	
L3	150	300	150	
L4	250 (5)*1	250 (5)*1	250 (5)*1	

*1 At the time of the installation at () dimension, Secure space of 250mm in lateral (L4) by unit movement at the time of the exchange work of the compressor.

FDC71VNP

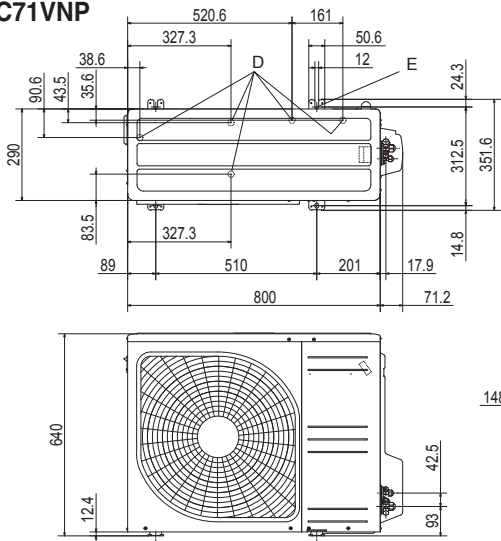

Symbol	Content
A	Service valve connection (gas side) $\phi 12.7(1/2")$ (Flare)
B	Service valve connection (liquid side) $\phi 6.35(1/4")$ (Flare)
C	Pipe/cable draw-out hole
D	Drain discharge hole $\phi 20 \times 5$ places
E	Anchor bolt hole M10 \times 4 places

- Notes
- (1) It must not be surrounded by walls on the four sides.
 - (2) The unit must be fixed with anchor bolts. An anchor bolt must not protrude more than 15mm.
 - (3) Where the unit is subject to strong winds, lay it in such a direction that the blower outlet faces perpendicularly to the dominant wind direction.
 - (4) Leave 1m or more space above the unit.
 - (5) A wall in front of the blower outlet must not exceed the unit's height.
 - (6) The model name label is attached on the lower right corner of the front panel.

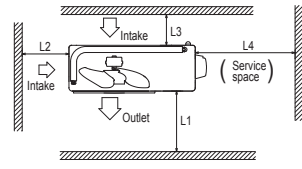

Minimum installation space

Dimensions	Examples of installation			
	I	II	III	IV
L1	Open	280	280	180
L2	100	75	Open	Open
L3	100	80	80	80
L4	250	Open	250	Open

FDC90VNP1

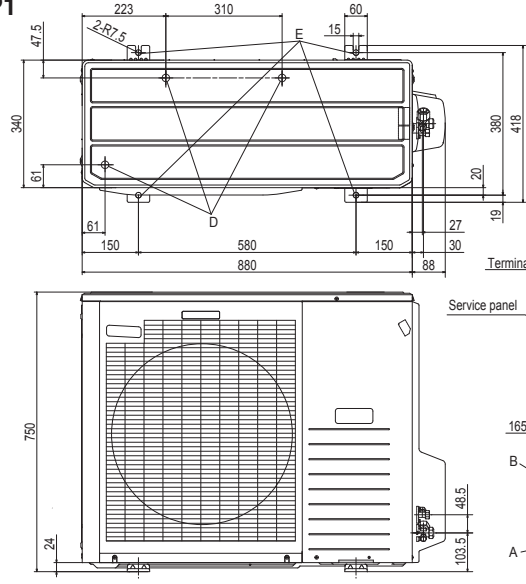

- Notes
- (1) It must not be surrounded by walls on four sides.
 - (2) The unit must be fixed with anchor bolts. An anchor bolt must not protrude more than 15mm.
 - (3) Where the unit is subjected to strong winds, lay it in such a direction that the blower outlet faces perpendicularly to the dominant wind direction.
 - (4) Leave 1m or more space above the unit.
 - (5) A wall in front of the blower outlet must not exceed the unit's height.
 - (6) The model name label is attached on the lower right corner of the front panel.

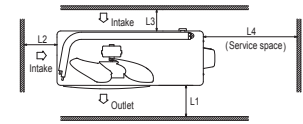

Minimum installation space

Dimensions	Examples of installation		
	I	II	III
L1	Open	Open	500
L2	300	250	Open
L3	100	150	100
L4	250	250	250

Symbol	Content
A	Service valve connection (gas side) $\phi 15.88(5/8")$ (Flare)
B	Service valve connection (liquid side) $\phi 9.52(3/8")$ (Flare)
C	Pipe/cable draw-out hole
D	Drain discharge hole $\phi 20 \times 3$ places
E	Anchor bolt hole M10 \times 4 places

FDC100VNP

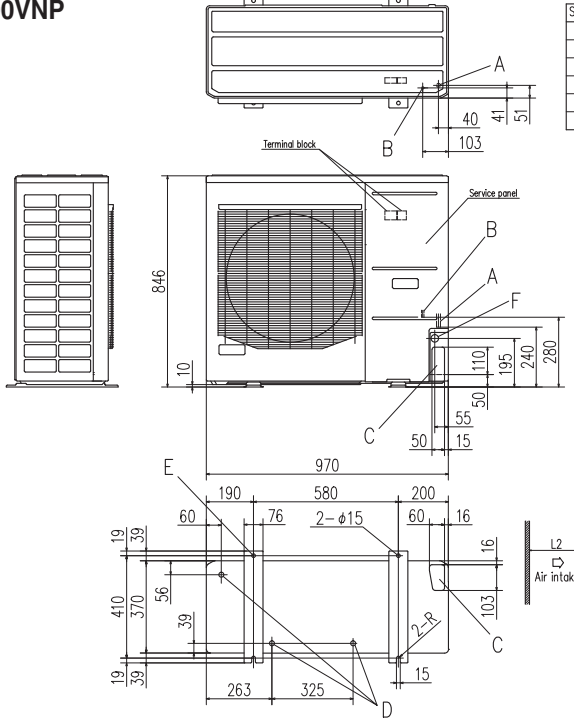

Symbol	Content
A	Service valve connection (gas side) $\phi 15.88(5/8")$ (Flare)
B	Service valve connection (liquid side) $\phi 9.52(3/8")$ (Flare)
C	Pipe/cable draw-out hole
D	Drain discharge hole $\phi 20 \times 3$ places
E	Anchor bolt hole M10 \times 4 places
F	Cable draw-out hole $\phi 30 \times 3$ places

- Notes
- (1) It must not be surrounded by walls on the four sides.
 - (2) The unit must be fixed with anchor bolts. An anchor bolt must not protrude more than 15mm.
 - (3) Where the unit is subject to strong winds, lay it in such a direction that the blower outlet face is perpendicular to the dominant wind direction.
 - (4) Leave 1m or more space above the unit.
 - (5) A wall in front of the blower outlet must not exceed the unit's height.
 - (6) The model name label is attached on the service panel.

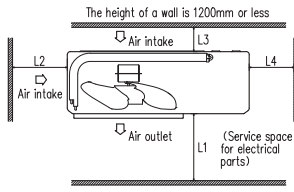

Minimum installation space

Dimensions	Examples of installation		
	I	II	III
L1	Open	Open	500
L2	300	250	Open
L3	100	150	100
L4	250	250	250

Unit: mm

ENERGY EFFICIENT AND ENVIRONMENTALLY CONSCIOUS

Several radical design changes and engineering developments have brought about a vast improvement in energy efficiency and environmental protection.

ENERGY LABEL

SEER and SCOP is defined in European regulations listed below.

No.626/2011 of 4 May 2011: energy labeling of air-conditioners (below cooling capacity 12kW).
No.206/2012 of 6 March 2012: requirement for air-conditioners and comfort fans.

Seasonal efficiency is the new way of rating the true efficiency of heating and cooling products over an entire year.

Set by the EU's new regulation implementing Eco-Design Directive for Energy Related Product (ErP) which specifies the minimum efficiency of air-conditioners manufacturers must integrate into their products.

The new Seasonal Efficiency rating system that must be used for heating and cooling by all manufacturers are;

SEER - Seasonal Efficiency Ratio (value in cooling)

SCOP - Seasonal Coefficient of Performance (value in heating)

The new rating system will indicate the true efficiency of the energy using product at specified condition.

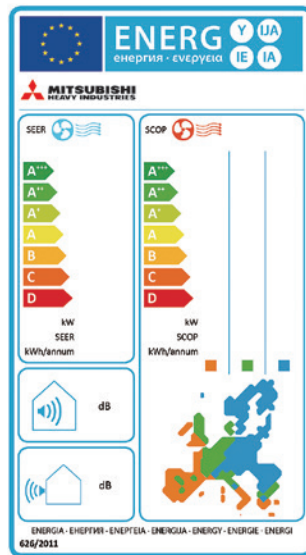

Employment of lead-free solder

Adapted to RoHS directive

RoHS:Restriction of Hazardous substances

In order to avoid the release of hazardous substances into the environments, all models have utilized lead-free solder application. It has been considered to be difficult to use lead-free solder for practical applications because it requires higher solder temperatures at assembly, which can jeopardize reliability. However our PbF soldering method can produce a higher quality lead-free printed circuit board.

Employment of R410A

All models use refrigerant R410A characterized by the ozone depletion coefficient being 0.

Excellent Energy Saving

High performance and excellent energy savings are achieved at the same time by heat exchanger's increased capacity and employment of high efficiency DC motor.

Indoor unit	FDT40VG	FDT50VG	FDT60VG	FDT71VG	FDT100VG	FDT100VG	FDT40VGx2	FDT50VGx2	FDT50VGx2
Outdoor unit	SRC40ZSX-S	SRC50ZSX-S	SRC60ZSX-S	FDC71VNX	FDC100VNX	FDC100VNX	FDC71VNX	FDC100VNX	FDC100VNX
Energy class (cooling/heating)	A++/A+	A++/A++	A++/A++	A+/A+	A+/A+	A+/A+	A+/A+	A+/A+	A+/A+
SEER	8.28	7.76	8.26	5.72	5.90	5.90	5.77	5.92	5.92
SCOP (Average climate)	4.45	4.61	5.00	4.34	4.32	4.32	4.34	4.16	4.16
Pdesign (cooling/heating (@-10°C))	kW 4.0/3.8	5.0/4.1	5.6/4.7	7.1/5.8	10.0/11.2	10.0/11.2	7.1/5.8	10.0/11.2	10.0/11.2
Annual electricity consumption (cooling/heating)	kWh/a 170/1197	226/1246	238/1317	435/1870	594/3626	594/3626	431/1872	592/3774	592/3774
Refrigerant (R410A)	GWP charge kg/TCO ₂ e 1.5/3.132				1975		2.95/6.160		4.5/9.396
Designated heating season	Average								

Indoor unit	FDT100VG	FDT100VG	FDT50VGx2	FDT50VGx2	FDT71VG	FDT100VG	FDT100VG	FDT100VG	FDT40VG	FDT50VG
Outdoor unit	FDC100VNA	FDC100VSA	FDC100VNA	FDC100VSA	FDC71VNP	FDC90VNP1	FDC100VNP	FDC100VNP	SRC40ZSX-S	SRC50ZSX-S
Energy class (cooling/heating)	A++/A+	A++/A+	A++/A+	A++/A+	A++/A+	A++/A+	A++/A+	A++/A+	A++/A+	A++/A+
SEER	6.78	6.78	6.89	6.89	6.14	6.78	6.78	6.78	6.93	6.49
SCOP (Average climate)	4.52	4.52	4.47	4.47	4.27	4.12	4.53	4.53	4.37	4.30
Pdesign (cooling/heating (@-10°C))	kW 10.0/8.5	10.0/8.5	10.0/8.5	10.0/8.5	7.1/5.7	9.0/8.1	10.0/8.1	10.0/8.1	4.0/4.0	5.0/4.3
Annual electricity consumption (cooling/heating)	kWh/a 516/2631	516/2631	508/2662	508/2662	405/1870	465/2756	517/2505	517/2505	202/1281	270/1402
Refrigerant (R410A)	GWP charge kg/TCO ₂ e 3.8/7.934				1975		1.6/3.341		2.1/4.385	
Designated heating season	2.55/5.324		1.5/3.132		Average					

Indoor unit	FDT60VG	FDT40VGx2	FDT50VGx2	FDT50VGx2	FDT50VGx2	FDT50VGx2	FDT50VGx2	FDT50VGx2	FDT50VGx2
Outdoor unit	SRC60ZSX-S	FDC71VNX	FDC100VNX	FDC100VNX	FDC100VSA	FDC100VSA	FDC71VNX	FDC100VNX	FDC100VNX
Energy class (cooling/heating)	A++/A+	A/A+	A/A	A/A	A+/A+	A+/A+	A/A	A/A+	A/A+
SEER	6.39	5.50	5.56	5.56	6.00	6.00	5.24	5.22	5.19
SCOP (Average climate)	4.09	4.05	3.87	3.87	4.38	4.38	3.90	4.10	4.10
Pdesign (cooling/heating (@-10°C))	kW 5.6/5.4	7.1/6.0	10.0/10.8	10.0/10.8	10.0/8.4	10.0/8.4	7.1/7.0	10.0/13.0	10.0/13.0
Annual electricity consumption (cooling/heating)	kWh/a 307/1848	453/2077	630/3910	630/3910	584/2682	584/2682	475/2513	670/4437	675/4441
Refrigerant (R410A)	GWP charge kg/TCO ₂ e 1.5/3.132		2.95/6.160		4.5/9.396		3.8/7.934		2.95/6.160
Designated heating season	4.5/9.396		1.5/3.132		Average				

Indoor unit	FDU100VF2	FDU100VF2	FDU1VF1	FDU100VF2	FDU100VF2	FDU100VF2	FDU100VF2	FDU100VF2	FDU100VF2
Outdoor unit	FDC100VNA	FDC100VSA	FDC71VNP	FDC90VNP1	FDC100VNP	SRC40ZSX-S	SRC50ZSX-S	SRC60ZSX-S	FDC71VNX
Energy class (cooling/heating)	A++/A+	A++/A+	A++/A+	A++/A	A++/A+	A+/A+	A+/A+	A++/A+	A/A
SEER	6.11	6.11	5.73	6.56	6.36	6.01	5.68	6.42	5.24
SCOP (Average climate)	4.19	4.19	4.00	3.98	4.13	4.15	4.36	4.37	3.90
Pdesign (cooling/heating (@-10°C))	kW 10.0/8.5	10.0/8.5	7.1/5.7	9.0/8.1	10.0/8.1	4.0/3.5	5.0/4.3	5.6/5.4	7.1/7.0
Annual electricity consumption (cooling/heating)	kWh/a 573/2843	573/2843	434/1995	480/2848	551/2746	233/1182	309/1382	306/1731	475/2513
Refrigerant (R410A)	GWP charge kg/TCO ₂ e 3.8/7.934		1.6/3.341		2.1/4.385		2.55/5.324		1.5/3.132
Designated heating season	4.5/9.396		2.95/6.160		Average				

* R410A refrigerant contained in the products is a fluorinated greenhouse gas listed in Regulation (EU) No 517/2014.

* SEER/SCOP are based on EN14825:2016 and Commission regulation(EU) No.2016/2281. Temperature conditions for calculating SCOP are based on "Average climate".

* 'tonne(s) of CO₂ equivalent' means a quantity of greenhouse gases- expressed as the product of the weight of the greenhouse gases in metric tonnes and of their global warming potential.

Indoor unit	FDMU100VF2	FDMU100VF2	FDMU40VFX2	FDMU50VFX2	FDMU50VFX2	FDMU100VF2	FDMU100VF2	FDMU50VFX2	FDMU50VFX2
Outdoor unit	FDC100VNX	FDC100VSX	FDC71VNX	FDC100VNX	FDC100VSX	FDC100VNA	FDC100VSA	FDC100VNA	FDC100VSA
Energy class (cooling/heating)	A/A+	A/A+	A+/A+	A/A	A/A	A++/A+	A++/A+	A/A	A/A
SEER	5.22	5.19	5.61	5.14	5.11	6.11	6.11	5.50	5.50
SCOP (Average climate)	4.10	4.10	4.05	3.88	3.87	4.19	4.19	3.94	3.94
Pdesign (cooling/heating (@-10°C))	kW	10.0/13.0	10.0/13.0	7.1/7.0	10.0/10.0	10.0/10.0	10.0/8.5	10.0/8.5	10.0/8.5
Annual electricity consumption (cooling/heating)	kWh/a	670/4437	675/4441	444/2422	681/3611	685/3614	573/2843	573/2843	637/3022
Refrigerant (R410A)	GWP	1975							
	charge kg/TCO ₂ e	4.5/9.396				2.95/6.160		4.5/9.396	
Designated heating season	Average								

Indoor unit	FDMU71VF1	FDMU100VF2	FDMU100VF2	SRK50ZSX-Wx2	SRK50ZSX-Wx2	SRK100ZR-S	SRK100ZR-S	SRK100ZR-S	FDE40VG	FDE50VG
Outdoor unit	FDC71VNP	FDC90VNP1	FDC100VNP	FDC100VNX	FDC100VSX	FDC100VNA	FDC100VSA	FDC100VNP	SRC40ZSX-S	SRC50ZSX-S
Energy class (cooling/heating)	A+/A+	A++/A	A++/A+	A++/A+	A++/A+	A++/A+	A++/A+	A++/A+	A++/A	A++/A
SEER	5.73	6.56	6.36	6.11	6.11	6.26	6.26	6.60	6.46	6.10
SCOP (Average climate)	4.00	3.98	4.13	4.16	4.16	4.33	4.33	4.40	3.93	3.92
Pdesign (cooling/heating (@-10°C))	kW	7.1/5.7	9.0/8.1	10.0/8.1	10.0/10.4	10.0/10.4	10.0/8.5	10.0/8.5	10.0/7.2	4.0/3.0
Annual electricity consumption (cooling/heating)	kWh/a	434/1995	480/2848	551/2746	574/3504	574/3504	560/2750	560/2750	531/2289	217/1069
Refrigerant (R410A)	GWP	1975								
	charge kg/TCO ₂ e	1.6/3.341	2.1/4.385	2.55/5.324	4.5/9.396		3.8/7.934		2.55/5.324	1.5/3.132
Designated heating season	Average									

Indoor unit	FDE60VG	FDE71VG	FDE100VG	FDE100VG	FDE40VGx2	FDE50VGx2	FDE50VGx2	FDE100VG	FDE100VG	
Outdoor unit	SRC60ZSX-S	FDC71VNX	FDC100VNX	FDC100VSX	FDC71VNX	FDC100VNX	FDC100VSX	FDC100VNA	FDC100VSA	
Energy class (cooling/heating)	A++/A+	B/A+	A+/A+	A+/A+	A/A+	A/A	A/A	A++/A+	A++/A+	
SEER	6.72	4.87	5.89	5.84	5.26	5.53	5.49	6.35	6.35	
SCOP (Average climate)	4.08	4.00	4.18	4.17	4.09	3.94	3.94	4.31	4.31	
Pdesign (cooling/heating (@-10°C))	kW	5.6/4.3	7.1/6.0	10.0/11.2	10.0/11.2	7.1/6.0	10.0/10.8	10.0/10.8	10.0/8.5	
Annual electricity consumption (cooling/heating)	kWh/a	292/1475	511/2102	595/3754	599/3758	473/2054	634/3836	638/3840	552/2762	
Refrigerant (R410A)	GWP	1975								
	charge kg/TCO ₂ e	1.5/3.132	2.95/6.160	4.5/9.396		2.95/6.160	4.5/9.396		3.8/7.934	
Designated heating season	Average									

Indoor unit	FDE50VGx2	FDE50VGx2	FDE71VNP	FDE100VG	FDE100VG	PDF71VD1	PDF100VD2	PDF100VD2	PDF100VD2	
Outdoor unit	FDC100VNA	FDC100VSA	FDC71VNP	FDC90VNP1	FDC100VNP	FDC71VNX	FDC100VNX	FDC100VSX	FDC100VNA	
Energy class (cooling/heating)	A+/A+	A+/A+	A++/A+	A++/A+	A++/A+	B/A	A/A	A/A	A+/A+	
SEER	5.71	5.71	6.35	6.63	6.73	4.80	5.20	5.17	5.70	
SCOP (Average climate)	4.10	4.10	4.22	4.25	4.44	3.81	3.80	3.80	4.00	
Pdesign (cooling/heating (@-10°C))	kW	10.0/8.5	10.0/8.5	7.1/5.8	9.0/8.2	10.0/8.1	7.1/6.7	10.0/13.0	10.0/13.0	
Annual electricity consumption (cooling/heating)	kWh/a	613/2904	613/2904	392/1925	475/2704	521/2556	518/2464	673/4792	678/4795	
Refrigerant (R410A)	GWP	1975								
	charge kg/TCO ₂ e	3.8/7.934		1.6/3.341	2.1/4.385	2.55/5.324	2.95/6.160	4.5/9.396	4.5/9.396	3.8/7.934
Designated heating season	Average									

Indoor unit	PDF100VD2	PDF71VD1	PDF100VD2	PDF100VD2	
Outdoor unit	FDC100VSA	FDC71VNP	FDC90VNP1	FDC100VNP	
Energy class (cooling/heating)	A+/A+	A/A	A+/A+	A/A	
SEER	5.70	5.25	5.69	5.41	
SCOP (Average climate)	4.00	3.91	4.01	3.94	
Pdesign (cooling/heating (@-10°C))	kW	10.0/8.5	7.1/5.5	9.0/8.1	
Annual electricity consumption (cooling/heating)	kWh/a	614/2978	474/1972	554/2825	
Refrigerant (R410A)	GWP	1975			
	charge kg/TCO ₂ e	3.8/7.934	1.6/3.341	2.1/4.385	2.55/5.324
Designated heating season	Average				

SEER and SCOP is defined in European regulations listed below.

No.2016/2281: requirement for air-heating products, cooling products, high temperature process chillers and fan coil units. Seasonal efficiency is the new way of rating the true efficiency of heating and cooling products over an entire year.

Set by the EU's new regulation implementing Eco-Design Directive for Energy Related Product (ErP) which specifies the minimum efficiency of air-conditioners manufacturers must integrate into their products.

The new Seasonal Efficiency rating system that must be used for heating and cooling by all manufacturers are;

Indoor unit	FDT125VG	FDT140VG	FDT125VG	FDT140VG	FDT125VG	FDT140VG	FDT125VG	FDT140VG	FDT125VF
Outdoor unit	FDC125VNX	FDC140VNX	FDC125VSX	FDC140VSX	FDC125VNA	FDC140VNA	FDC125VSA	FDC140VSA	FDC125VNX
SEER	5.77	5.66	5.94	5.82	6.52	6.16	6.52	6.16	5.34
SCOP (Average climate)	4.08	4.04	4.03	3.99	4.38	4.28	4.38	4.28	3.87

Indoor unit	FDU140VF	FDU125VF	FDU140VF	FDU125VF	FDU140VF	FDU125VF	FDU140VF	FDU200VG	FDU250VG
Outdoor unit	FDC140VNX	FDC125VSX	FDC140VSX	FDC125VNA	FDC140VNA	FDC125VSA	FDC140VSA	FDC200VSA	FDC250VSA
SEER	5.22	5.49	5.36	5.26	5.08	5.26	5.08	5.06	4.82
SCOP (Average climate)	3.85	3.91	3.88	4.13	4.01	4.13	4.01	3.52	3.51

Indoor unit	FDMU125VF	FDMU140VF	FDMU125VF	FDMU140VF	FDMU125VF	FDMU140VF	FDMU125VF	FDMU140VF	FDE125VG
Outdoor unit	FDC125VNX	FDC140VNX	FDC125VSX	FDC140VSX	FDC125VNA	FDC140VNA	FDC125VSA	FDC140VSA	FDC125VNX
SEER	5.34	5.22	5.49	5.36	5.26	5.08	5.26	5.08	5.56
SCOP (Average climate)	3.87	3.85	3.91	3.88	4.13	4.01	4.13	4.01	3.71

Indoor unit	FDE140VG	FDE125VG	FDE140VG	FDE125VG	FDE140VG	FDE125VG	FDE140VG	PDF125VD	PDF140VD
Outdoor unit	FDC140VNX	FDC125VSX	FDC140VSX	FDC125VNA	FDC140VNA	FDC125VSA	FDC140VSA	FDC125VNX	FDC140VNX
SEER	5.41	5.74	5.56	6.03	5.76	6.03	5.76	4.97	4.80
SCOP (Average climate)	3.66	3.66	3.62	4.30	4.15	4.30	4.15	3.60	3.56

Indoor unit	PDF125VD	PDF140VD	PDF125VD	PDF140VD	PDF125VD	PDF140VD
Outdoor unit	FDC125VSX	FDC140VSX	FDC125VNA	FDC140VNA	FDC125VSA	FDC140VSA
SEER	5.11	4.94	5.36	5.09	5.36	5.03
SCOP (Average climate)	3.60	3.60	3.96	4.16	3.96	4.16

Before starting use

Heating performance

The heating performance values (kW) described in the catalogue are the values obtained by operating at an outdoor temperature of 7°C and indoor temperature of 20°C as set forth in the ISO Standards. As the heating performance decreases the outdoor temperature drops, if the outdoor temperature is too low and the heating performance is insufficient, use other heating appliances as well.

Indication of sound values

The sound values are the values (A scale) measured in a chamber such as an anechoic chamber following the ISO Standards. In the actual installation state, the value is normally larger than the values given in the catalog due to the effect of surrounding noise and echo. Take this into consideration when installing.

Use in oil atmosphere

Avoid installing this unit in an atmosphere where oil scatters or builds up, such as in a kitchen or machine factory. If the oil adheres to the heat exchanger, the heat exchanging performance will drop, mist may be generated, and the synthetic resin parts may deform and break.

Use in acidic or alkaline atmosphere

If this unit is used in acidic atmosphere such as hot spring areas having high level of sulfuric gases or in alkaline atmosphere including ammonia or calcium chloride, places where the exhaust of the heat exchanger is sucked in, or at coastal areas where the unit is subject to salt breezes, the outer plate or heat exchanger, etc., will corrode. Please ask a dealer or specialist when you use an air conditioner in places differing from a general atmosphere.

Use in places with high ceilings

If the ceiling is high, install a circulator to improve the heat and air flow distribution when heating.

Refrigerant leakage

The refrigerant (R410A) used for Air conditioner is non-toxic and inflammable in its original state.

However, in consideration of a state where the refrigerant leaks into the room, measures against refrigerant leaks must be taken in small rooms where the tolerable level could be exceeded. Take measures by installing ventilation devices, etc.

Use in snowy areas

Take the following measures when installing the outdoor unit in snowy areas.

•Snow prevention

Install a snow-prevention hood so that the snow does not obstruct the air intake port or enter and freeze in the outdoor unit.

•Snow piling

In areas with heavy snow fall, the piled snow could block the air intake port. In this case, a frame that is 50cm or higher than the estimated snow fall must be installed underneath the outdoor unit.

Automatic defrosting device

If the temperature is low, and the humidity is high, frost will stick to the heat exchanger of the outdoor unit. If use is continued, the heating performance will drop.

The "Automatic defrosting device" will function to remove this frost.

After heating for approx. three to ten minutes, it will stop, and the frost will be removed. After defrosting, hot air will be blown again.

Servicing the air-conditioner

After the air-conditioner is used for several seasons, dirt will build up in the air-conditioner causing the performance to drop. In addition to regular servicing, we recommend the maintenance contract (charged for) by a specialist.

⚠ Safety Precautions

Air-conditioner usage target

The air-conditioner described in this catalog is a dedicated cooling/heating device for human use.

Do not use it for special applications such as the storage of food items, animals or plants, precision devices or valuable art, etc.

This could cause the quality of the items to drop, etc.

Do not use this for cooling vehicles or ships. Water leakage or current leaks could occur.

Before use

Always read the "User's Manual" thoroughly before starting use.

Installation

Always commission the installation to a dealer or specialist. Improper installation will lead to water leakage, electric shocks and fires.

Make sure that the outdoor unit is stable in installation. Fix the unit to stable base.

Usage place

Do not install in places where combustible gas could leak or where there are sparks.

Installation in a place where combustible gas could be generated, flow or accumulate, or places containing carbon fibers could lead to fires.



(Wholly-owned subsidiary of MITSUBISHI HEAVY INDUSTRIES, LTD.)

16-5, Konan 2-chome, Minato-ku, Tokyo, 108-8215 Japan
<http://www.mhi-mth.co.jp/en/>

Our factories are ISO9001 and ISO14001 certified.

Certified ISO 9001



Certificate Number : JQA-0709



Certificate: A4 109 980813



Certificate Number : 4333-2007-AQ-RIGC-RvA

Certified ISO 14001



Certificate Number : YKA4005636



Certificate: 04 104 980813



Certificate number : 02117E1016FRM

