

Application line up

Air and N₂ compressor

Air compressor and nitrogen compressor are used in several applications, such as air separation, PTA, ammonia and other chemical plants. Application range is as follows;

- Flow volume 20,000 to 75,000Am³/h with pressure up to 100barA
- Flow volume 75,000 to 450,000Am³/h with pressure up to 50barA
- Flow volume up to 1,000,000Am³/h with pressure up to 8barA

Fuel gas compressor

Integrally geared fuel gas compressor is fully standardized to be suitable for low / middle pressure fuel gas condition. Compressor core unit, motor driver, lube oil system, dry gas seal control unit and process gas piping are completely packaged on common base skid to minimize site installation work. Flow volume is up to 200,000Am³/h with discharge pressure up to 60barA.

Carbon dioxide (CO₂) compressor

Fields of application are CCS, EOR and CO₂ separation in IGCC, oxy-fuel, pre combustion and post combustion processes. Flow volume is up to 200,000Am³/h with discharge pressure up to 200barA.

Expander

Expander, integrally geared radial type, is designed based on proven integrally geared compressor concept as power recovery system. Fields of application are PTA, Nitric acid and others. Gas inlet temperature is up to 550°C. Exhaust volume flow is up to 550,000Am³/h.



Nitrogen gas compressor (Combined type) for air separation plant **Fuel gas compressor for power plant** **Booster air compressor for power station IGCC**



Air compressor (6-stage) and gas expander for PTA plant

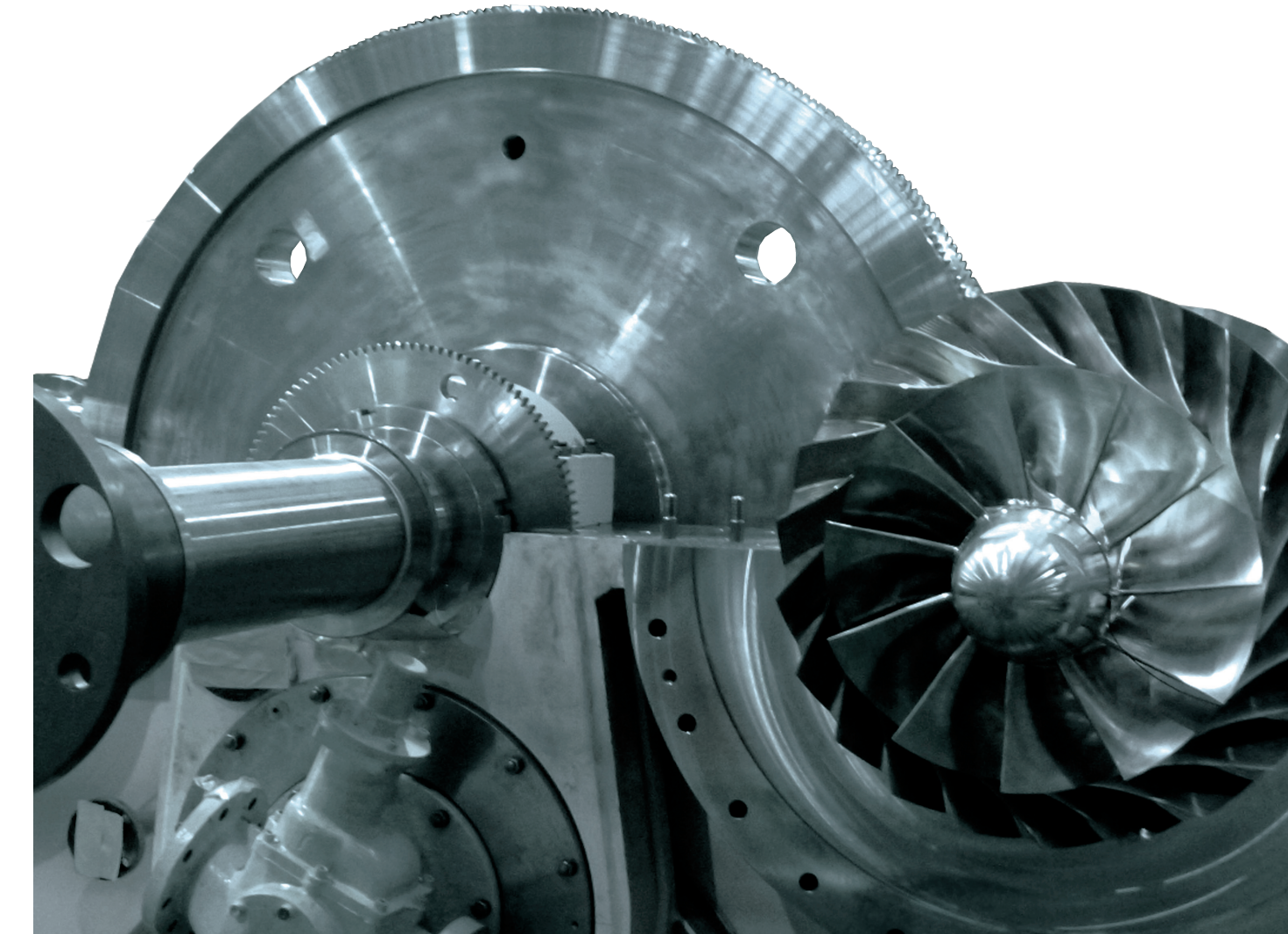

MITSUBISHI INTEGRALLY GEARED COMPRESSOR

Technical evolutions of integrally geared compressor

Mitsubishi Integrally geared compressor has found widespread application principally as air compressor, booster compressor, nitrogen-gas compressor, CO₂ compressor, natural gas compressor and vacuum pump. Mitsubishi integrally geared compressor has been designed to offer high efficiency and high reliability. Utilizing our R&D institutes we are continually developing innovative technologies.

Advantage of Mitsubishi integrally geared compressor

High efficiency and low running cost

3D impeller, optimum designed gear system and inter cooling system are applied for high efficiency compressor.

Reliable continuous operation with minimum maintenance

Mitsubishi integrally geared compressor is constructed with proven designed component for reliable continuous operation. All component of compressor (impeller, scroll casing, gear casing, gear, shaft, bearing) is designed by Mitsubishi own technology.

Optimized compressor system

Optimized compressor train is engineered and proposed for customer's requirement. Compressor train equipment (compressor, motor, steam turbine, expander) can be constructed considering with customer's required operating condition. Also, customer's requirement control can be accommodated into control system.

Quick and excellent after-sales service

Supervising service is ready for installation, test runs, and after-sales servicing to customer's requirement. Also, we can positively respond and propose to customer's required modification.

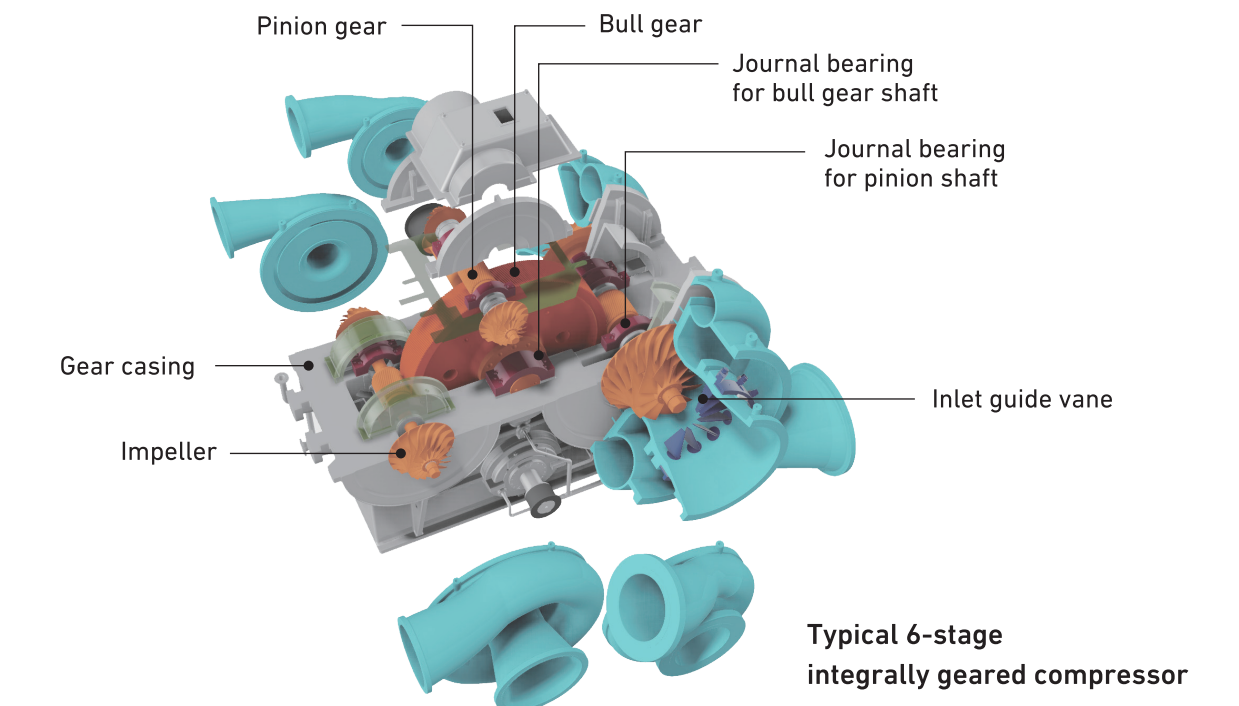

Typical 6-stage integrally geared compressor

Type of Mitsubishi integrally geared comprsoor

Application range

Compressor

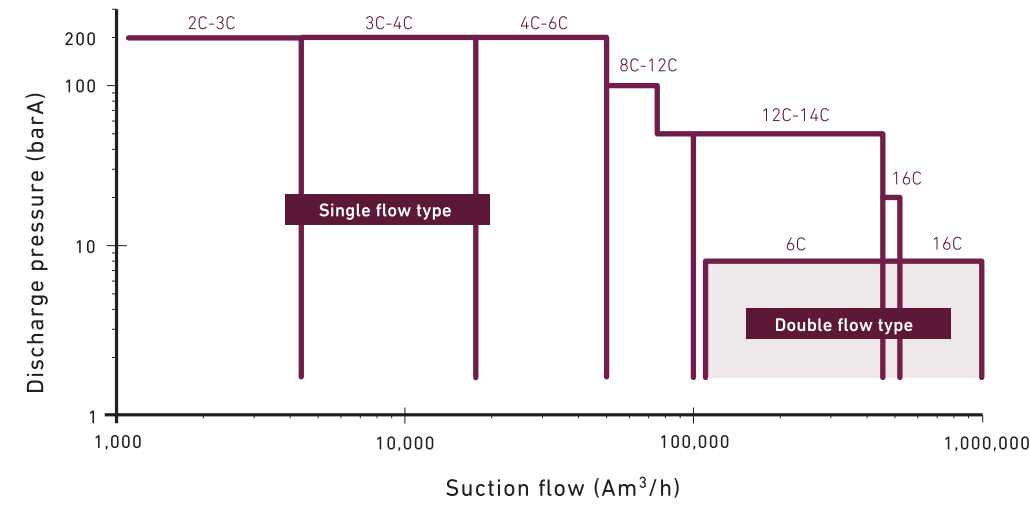

Expander

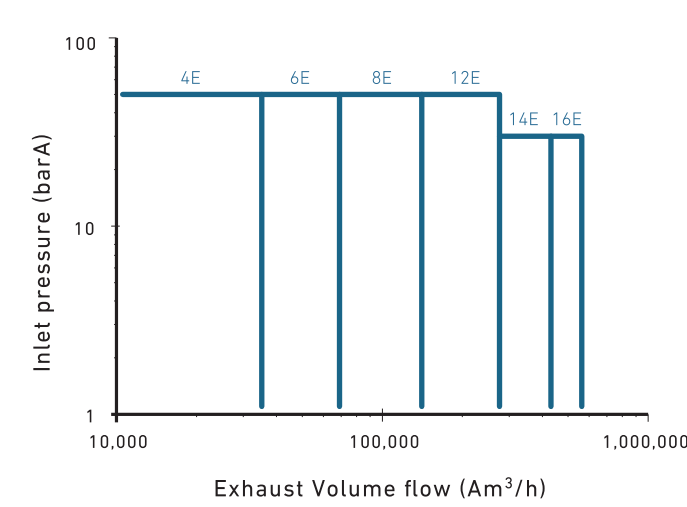

Model code

Mitsubishi integrally geared compressor models are generally indicated by a three-digit code.

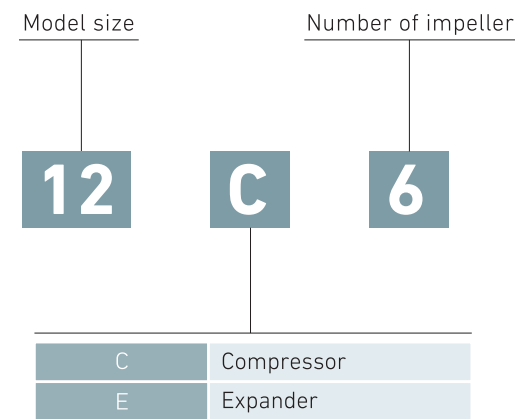

Gear arrangement

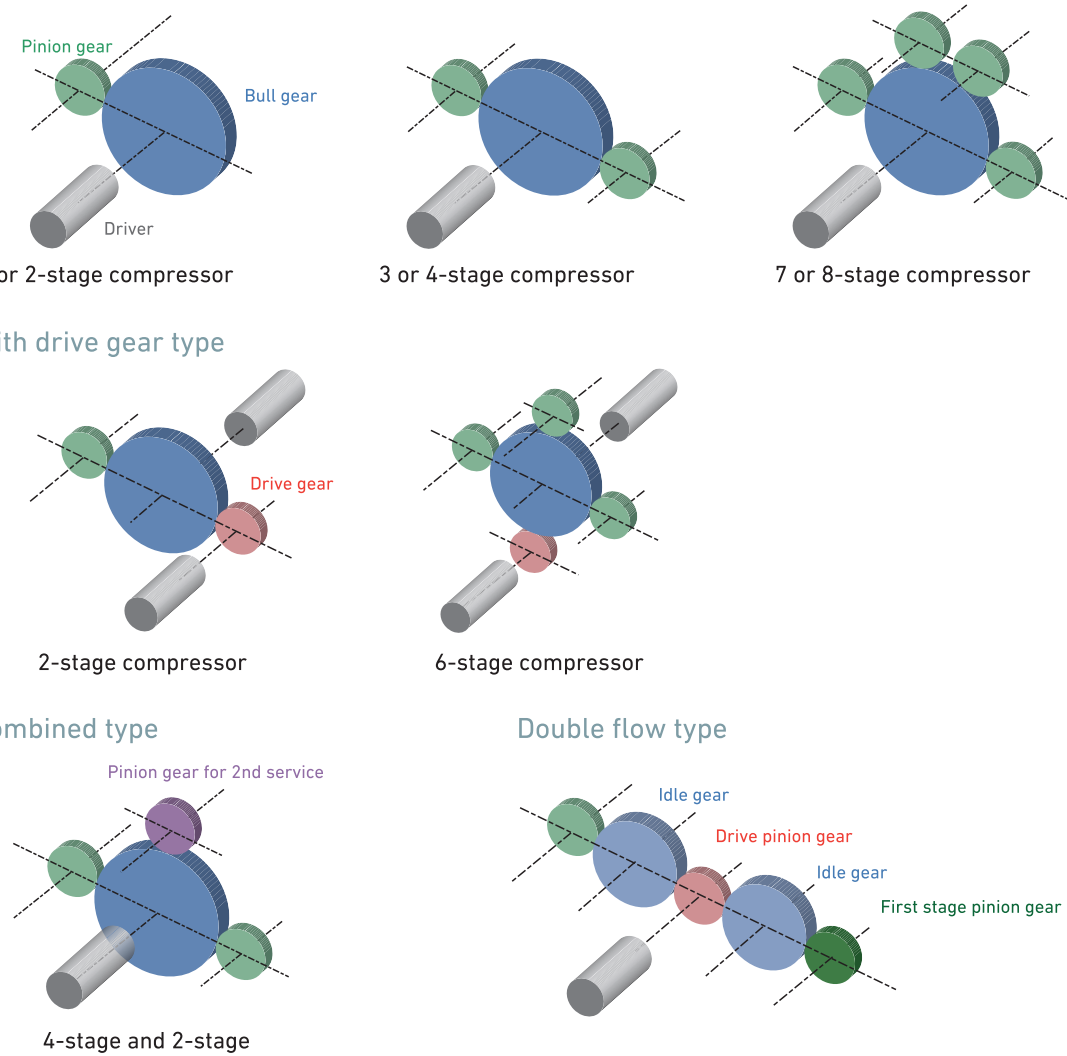

Design features

Gear casing

Gear casing is designed and constructed for easy checking the gear and bearings without removing the scroll casing by disassembling the upper side gear casing.

Pinion shaft

Each high speed pinion shaft has the impellers fitted on the end. The rotation speed is set at the optimized speed for the impeller performance. Pinion shaft assembly with impeller is removable design, for easy maintenance.

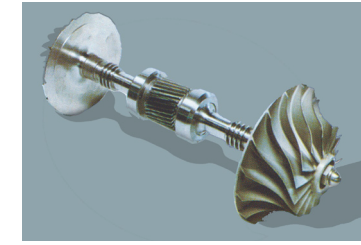

Impeller

MCO's full 3D impeller line up provides high efficiency and satisfies the design needs of wide range application from small to large volume flow. The performance of each impeller is tested and verified by our in-house R&D laboratory.

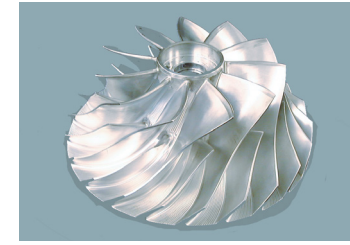

Speed increasing gear

Single helical gears are applied to raise the driver speed to impeller speed. The gear is made with heat-treating, precision polishing for stable operation. Speed increasing gear, key component of integrally geared compressor, is designed by Mitsubishi own criteria based on R&D. Minimum gear quality corresponds to AGMA standard.

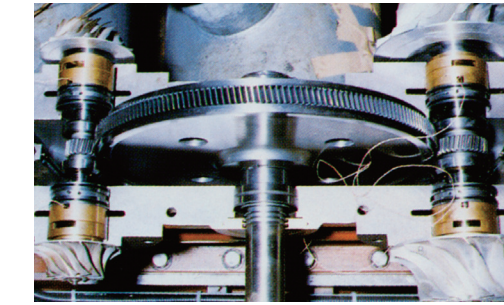

Idle gear arrangement for Double Flow Integrally Geared Compressor

Double Flow Integrally Geared Compressor (DF-IGC) is designed with idle gear arrangement and double identical suction,;

Compactness (by small size for 1st stage impellers)
Eliminated large bull gear
Lower GD2 & Starting torque
Driven by 4 (2)-pole EM or ST

Idle gear arrangement avoids large bull gear and multi-pole EM.

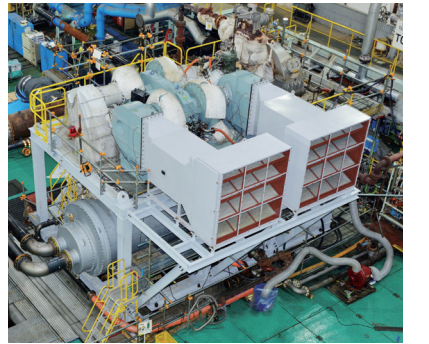

Shaft seal

Standard seal type is labyrinth seal. Between labyrinth seal and oil baffle, atmosphere open space is located for preventing the lubricating oil from entering into the process side.

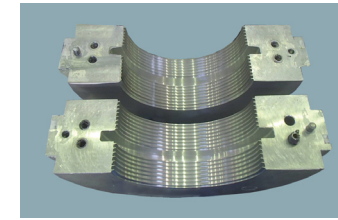

Optional seal system

Depend on the actual design and operating condition (Gas pressure level, Gas handled), optional seal systems are selected.

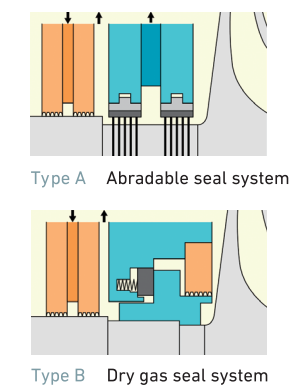

Journal bearing for pinion shaft

Tilting pad type journal bearings are applied for pinion shaft, considering with high speed and high bearing load. With the tilting-pad type journal bearing, stable rotating condition can be kept even if changing the compressor load.

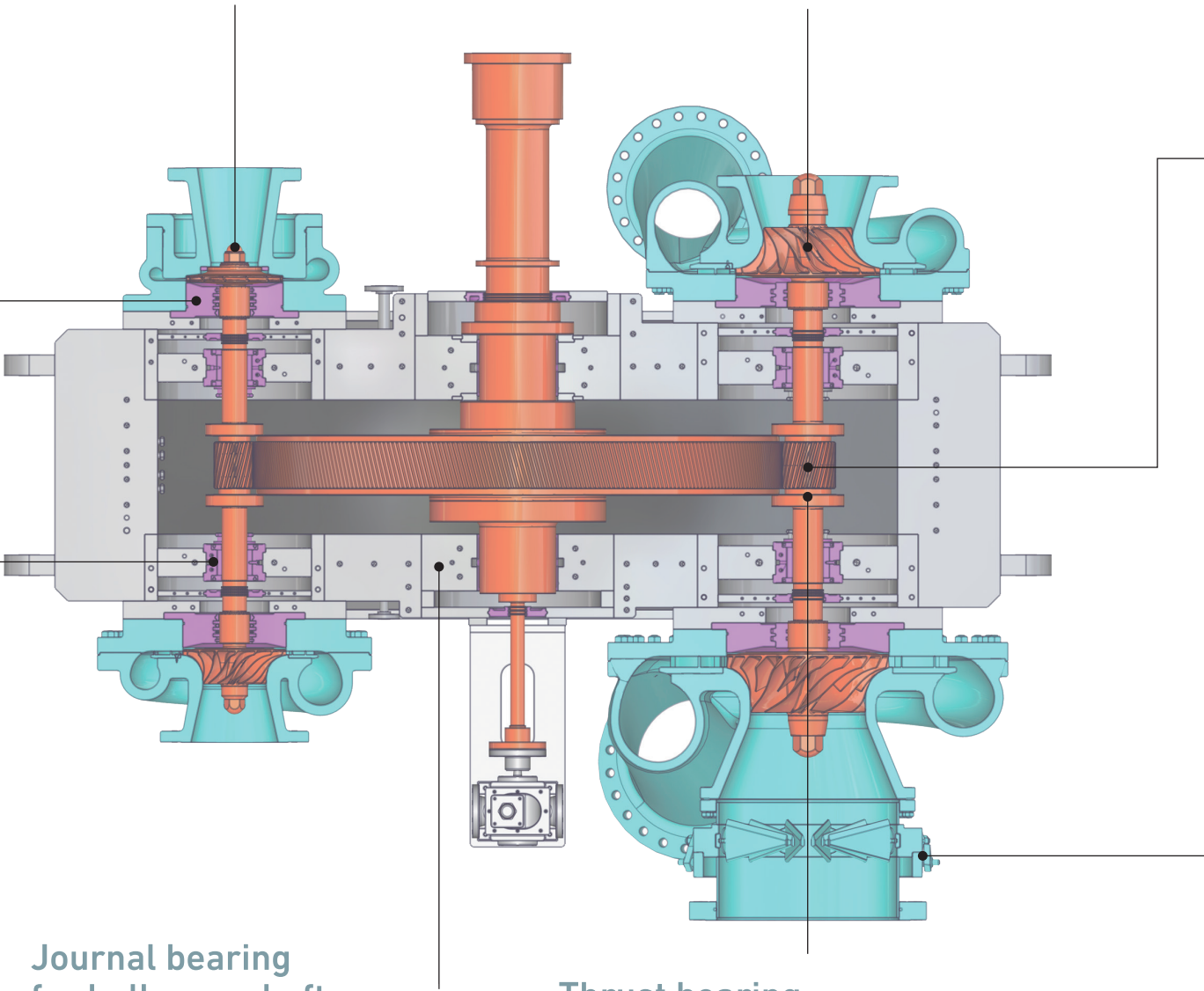
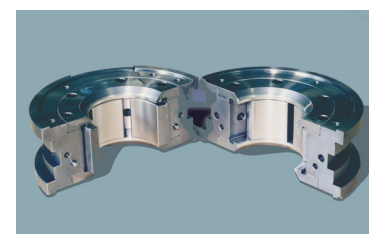

Journal bearing for bull gear shaft

Sleeve journal bearing is applied for low speed bull gear shaft.

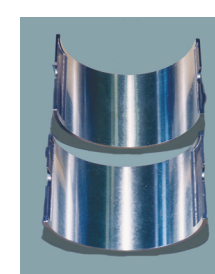

Thrust bearing

Thrust collar is applied for the thrust bearing of each pinion shaft. In this system, the thrust force of the compressor is transmitted to the thrust bearing of bull gear shaft by the pinion shaft thrust collar. Low mechanical loss design can be realized by applied thrust bearing system.

Inlet Guide Vane (IGV)

Movable inlet guide vanes enable a wide operating range. The inlet guide vanes are installed ahead of first stage or each stage as option.

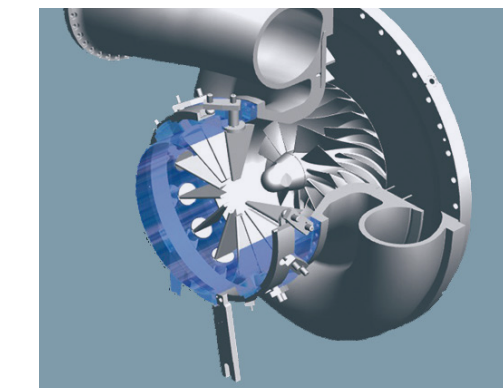
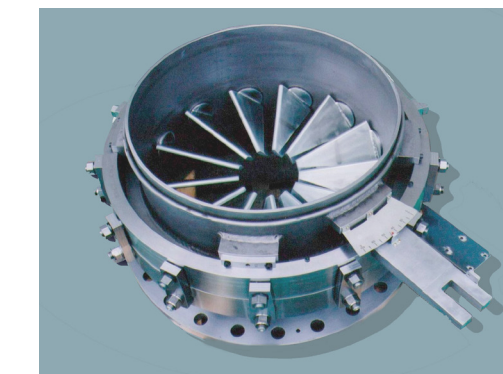

Auxiliary system design

MCO designs the integrated auxiliary system such as LO system, dry gas seal system, control system which provide the suitable operation of our compressors and drivers.

Ergonomics design

Ergonomics design by using 3D simulations can realize the optimum arrangement design of overall compressor train system, for each aspect as assembling, installation, operating and maintenance.

Booster air compressor module for air separation plant

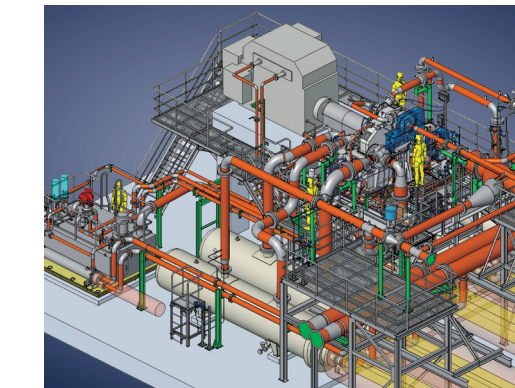

3D model

Final production at shop