

## Application line up

**Upstream** Gas gathering, Gas lift, Gas production and processing, Gas injection (Enhanced oil / Gas recovery), Refinery, LNG, Natural Gas Liquids (NGL), Gas To Liquid (GTL)

**Midstream** Gas pipeline, Gas storage, Fuel gas

**Downstream** Ethylene & Derivatives, Ammonia / Urea, Methanol, Air separation, Propane dehydrogenation (PDH), Nitric acid and other plants including off-shore services (FPSO, Floating LNG), CCS.



Offshore gas treatment plant

Pipeline station

Fertilizer plant

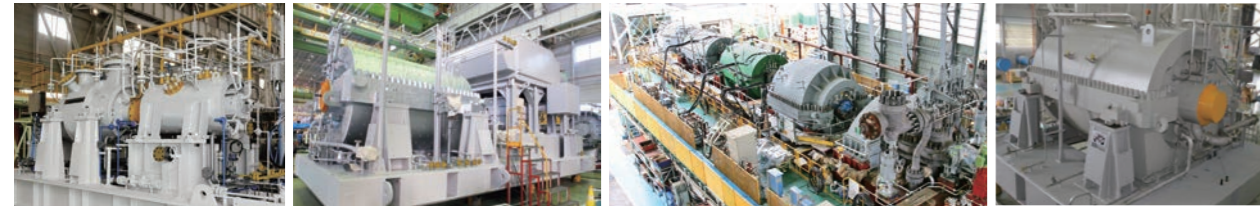

Gas injection compressor for FPSO

Main refrigerant compressor for LNG plant

Cracked gas compressor train for mega ethylene plant

Product gas compressor for PDH plant

### Vertically split (V-type) compressor

Vertically split compressors are applied for medium and high pressure services. This type of compressor consists of diaphragm bundle and casing. The diaphragm bundle forms a single unit with the head, bearing and seal, and the assembled bundle is fixed to casing by shear rings. The nozzle can be attached to the top, bottom, or side in accordance with customer's requirements.

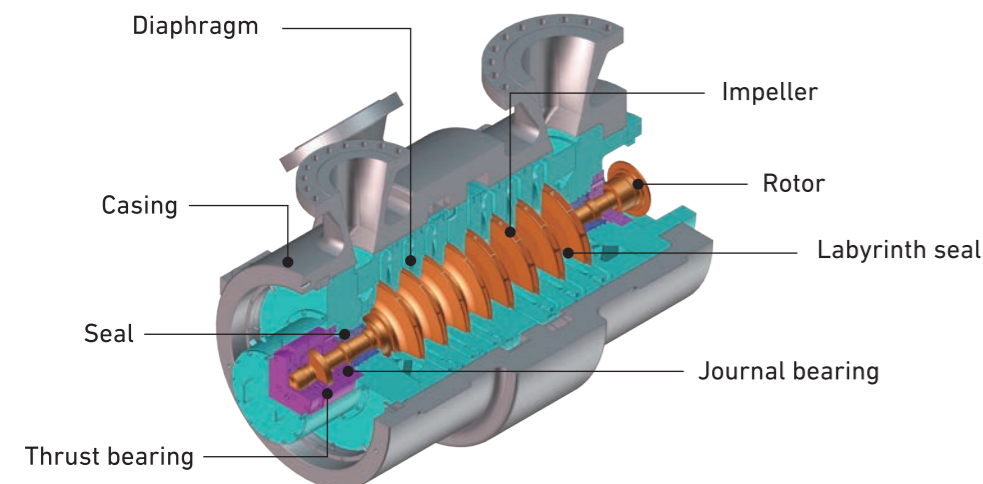

MITSUBISHI HEAVY INDUSTRIES COMPRESSOR CORPORATION  
4-6-22, Kan-on-shin-machi, Nishi-ku,  
Hiroshima, 733-8553 Japan  
TEL +81-82-291-2200



www.mhicompressor.com | spectra.mhi.com

MOVE THE WORLD FORWARD MITSUBISHI HEAVY INDUSTRIES GROUP



# MITSUBISHI CENTRIFUGAL COMPRESSOR

## Technical evolutions of compressor

### Mitsubishi Advanced Compressor (MAC)

Mitsubishi Heavy Industries Compressor Corporation (MCO) has manufactured well over a thousand compressor units for application in a wide range of industries since building Japan's first centrifugal compressor in 1917. Our original compressor brand called MAC (Mitsubishi Advanced Compressor) developed from 1980's, now play a vital role in oil & gas production, gas transportation, oil refining, petrochemicals and other processes. Utilizing our R&D institutes we are continuously developing innovative technologies.

### Advantage of MAC

- Stable superior performance
- High speed and compact design
- Easy maintenance
- Reliable long term operation
- Quick and excellent after-sales service

### Type and characteristic

#### Horizontally split (H-type) compressor

Horizontally split type compressor are applied for large flow and low / medium pressure service. This type of casing is split along the rotor shaft and bolted at the split line. The bearing and seal sections allow easy disassembly and assembly without removing the upper casing.

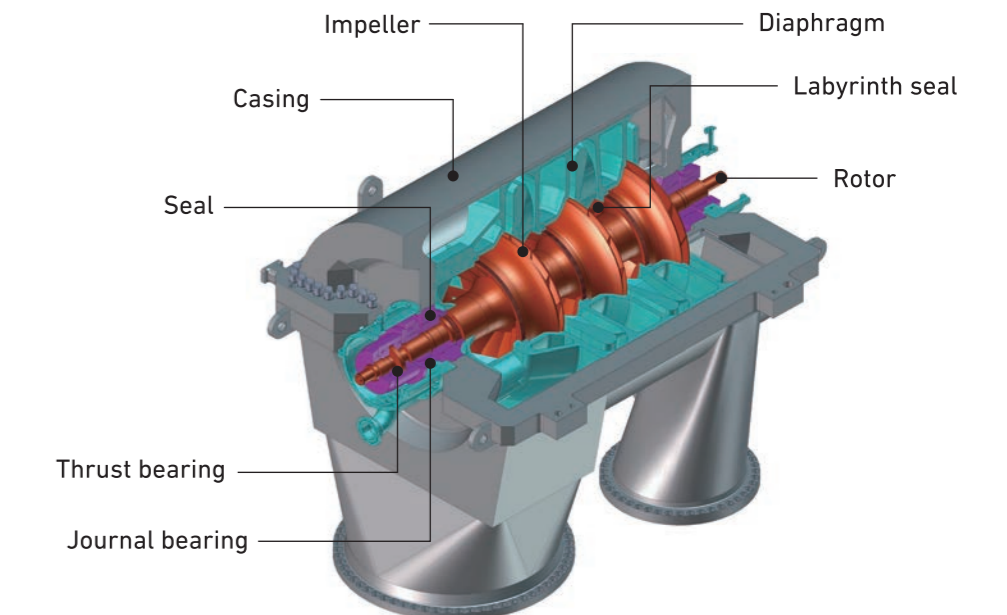

## Application range

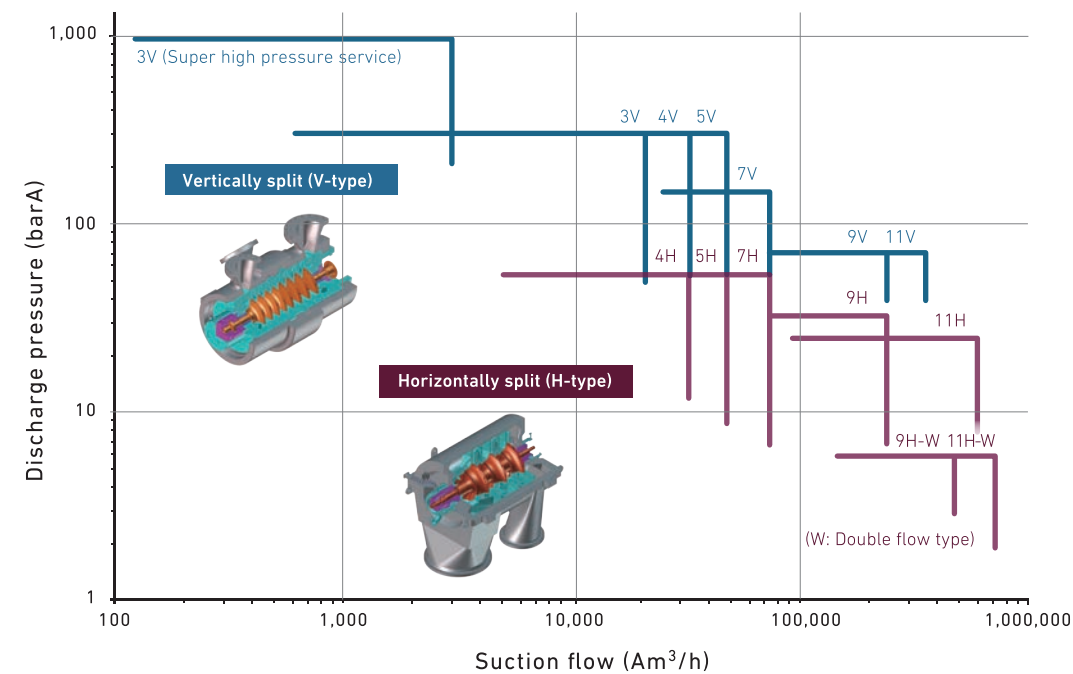

## Model code

MAC models are generally indicated by a four-digit code.

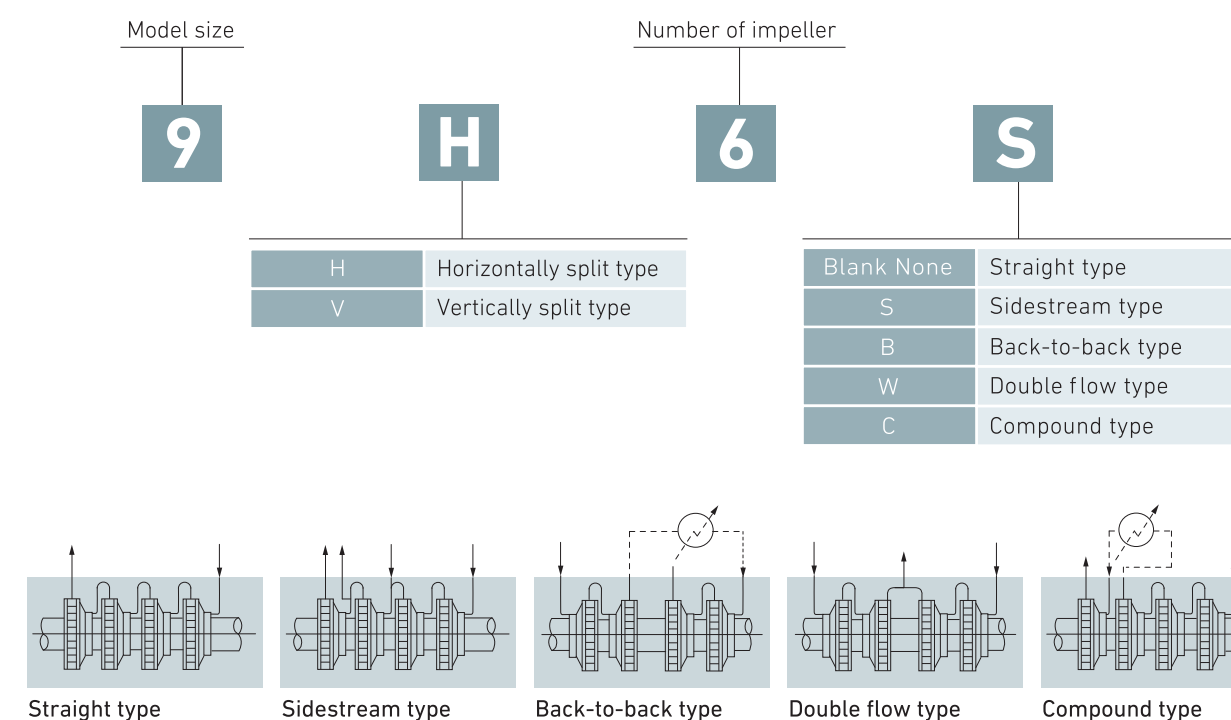

## Casing

Three type of casing can be applied.

1. Cast steel casing
2. Fabricated casing
3. Forged steel casing

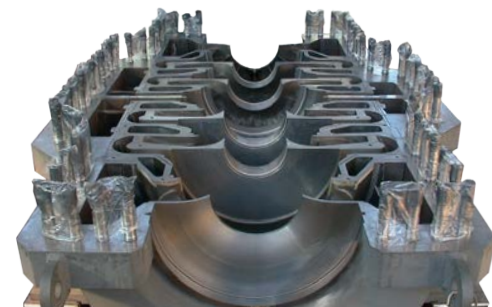

Fabricated casing for horizontally split type

## Overhang damper

Overhang damper can be applied to increase damping force for more stable operation.

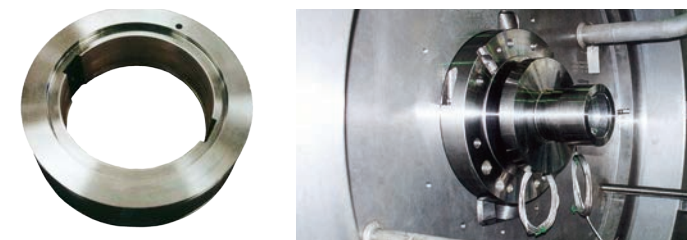

Overhang damper

## Bearing

### Oil lubricant bearing

#### • Journal bearing

Direct lubrication type tilting pad bearings are applied to increase the load capacity and to reduce mechanical losses.

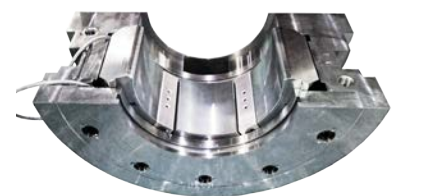

Journal bearing - Direct lubrication type

#### • Thrust bearing

Direct lubrication type self leveling multi pad bearing with load equalizing system is applied to increase the load capacity and to reduce mechanical losses.

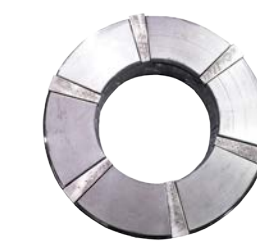

Thrust bearing - Direct lubrication type

#### • Active Magnetic Bearing (AMB)

For oil free operation, AMB can be applied in several application such as gas pipeline compressor.

## Diaphragm

The diaphragms form the flow passage: diffuser, return channel, sidestream. They are designed to minimize fluid losses as less as possible.

#### • Movable Inlet Guide Vane

For wide range operation, MCO can apply Movable Inlet Guide Vane (MIGV).

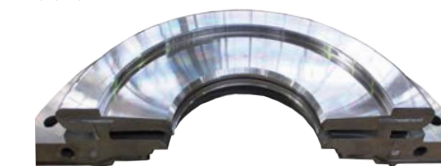

Diaphragm



Diaphragm assembly for vertically split type

## Rotor

The rotor consists of impellers, shaft, sleeves, balance piston and thrust disc.

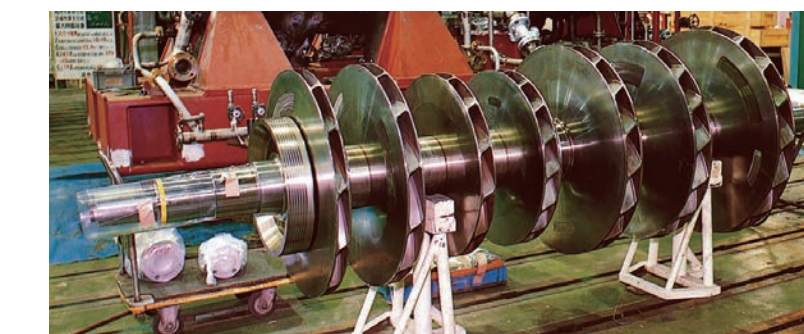

Rotor assembly

## Seal

Shaft seals prevent / reduce gas leakage from casing. Interstage seals reduce the leakage between stages. Following seal types are applicable.

#### • Shaft seal

Dry gas seal / Labyrinth seal / Oil film seal / Mechanical seal.

#### • Interstage seal/ Balance piston seal

Labyrinth seal / Abradable seal / Swirl canceller labyrinth seal / Hole pattern seal.

For improving rotordynamic stability, a swirl canceller labyrinth seal which generates counter gas flow to cancel swirl flow or a hole pattern seal can be applied.

## Impeller

MCO's full 3D impeller line up provides high efficiency and satisfies the design needs of wide range application from small to large volume flow. The performance of each impeller is tested and verified by our R&D laboratory.



3D impeller

#### • One piece impeller

For the low-weldability or narrow path type impellers, MCO has been developed weld less manufacturing.

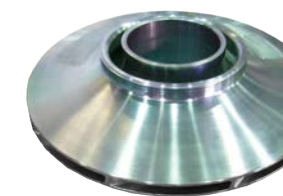

One piece impeller

## Super high pressure compressor

The MCO's design concept for the application of super high pressure compressor is to realize high performance with minimum compact body attaining light weight for easy installation and maintenance. MCO's super high pressure compressor has realized the wide operating range maintaining the high efficiency and stable operation. It can be applicable for high pressure and high density services such as CO2 injection of EOR, CCS, Gas processing plant, offshore equipment (FPSO).

### Available gas condition

Pressure Up to 1,000 bar  
Service Heavy to light molecular weight  
(CO2 100% ~ Natural gas)

## Module design

For Gas injection, FPSO, ASU and other plants, modularized packages can be provided.

#### • Modularized packages offer :

- Single lift transportation
- Streamlined field installation
- Shortened project schedule
- Total construction cost reduction

#### • Ergonomics design

Ergonomics design by using 3D simulations can realize the optimum arrangement of overall compressor train system, for each aspect of assembling, installation, operating and maintenance.

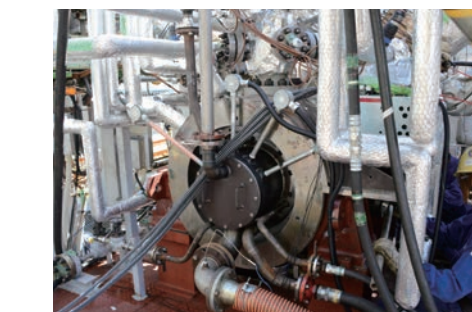
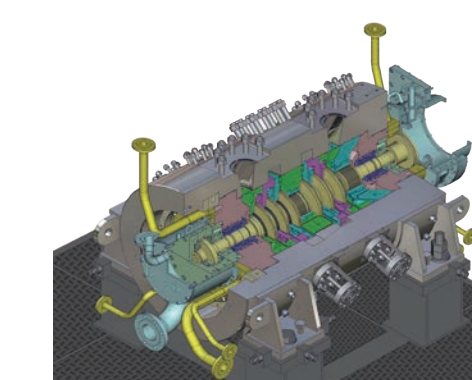

MCO super high pressure compressor

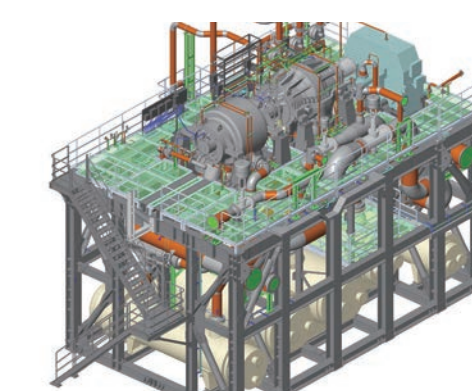

3D model



Nitrogen injection compressor module for ASU Plant