

MASS PRODUCTION REPORT OF C-BAND CHOKE MODE ACCELERATING STRUCTURE AND RF PULSE COMPRESSOR

K. Okihira, F. Inoue, Mitsubishi Heavy Industries, LTD.
 1-1, Wadamisaki-cho 1-chome, Hyogo-ku, Kobe, 652-8585 JAPAN
 T. Hashirano, S. Miura, Mitsubishi Heavy Industries, LTD.
 1-1, Itozaki Minami 1-chome, Mihara, Hiroshima, 729-0393 JAPAN
 H. Maesaka, T. Inagaki, T. Shintake, RIKEN / SPring-8,
 1-1-1, Kouto, Sayo-cho, Sayo-gun, Hyogo, 679-5148 JAPAN

Abstract

RIKEN and JASRI already completed the construction of XFEL/Spring8. Recently the facility was named “SACLA” (SPring-8 Angstrom Compact Free Electron LAsEr). The commissioning team succeeded in the XFEL laser oscillation of 0.8 Å wavelength in July 2011. Now the accelerator is stably operated for the XFEL commissioning. In this project, a C-band choke mode accelerating structure and C-band RF pulse compressor are employed to obtain a high acceleration gradient of more than 35 MeV/m. As of May 2010, we have completed the fabrication of all units and conducted RF measurements on them. It reports on the result of these 64 C-Band units.

INTRODUCTION

RIKEN and JASRI already completed the construction of XFEL/Spring8[1,2]. Recently the facility was named “SACLA” (SPring-8 Angstrom Compact Free Electron LAsEr). C band linear accelerator[3] is used to accelerate the electron in XFEL. The output of the klystron is compressed with the C-Band RF pulse compressor, and sent to C-Band choke mode accelerating structure. The accelerated gradient is obtained about twice compared with the case not compressed. From February 2007, MHI started mass production and the delivery of all components was completed in March 2010. It reports on the mass production passage of these 128 C-Band accelerating structures, and 64 C-Band RF pulse compressors and on the installation result of injector section.

MASS PRODUCTION

The XFEL facilities are composed of electron linac of 8GeV and vacuum sealing undulator. C-band accelerator is adopted in a main acceleration division of electron linac. Figure 1 shows the linac outline of XFEL Project. MHI took charge of the production of the part enclosed with a red frame in figure and the installation of the part enclosed with a blue frame in figure. We took charge of the production of almost all waveguides and acceleration structure expect for the L-band unit.

The production of all components was started in February 2007, the delivery began in January 2008. Although there was dormant period for three month due to the accelerating structure trouble, the deliveries of all components, C-band and S-band accelerating structure:136, C-band and S-band RF pulse compressor:68, C-bands, and S-band waveguides:952, were completed in two years until February 2010.

The average number of the delivery was 5 accelerating structures and 3 pulse compressor and 38 waveguides per month. The maximum number of the delivery was 8 accelerating structures and 6 pulse compressors and 72 waveguides per month.

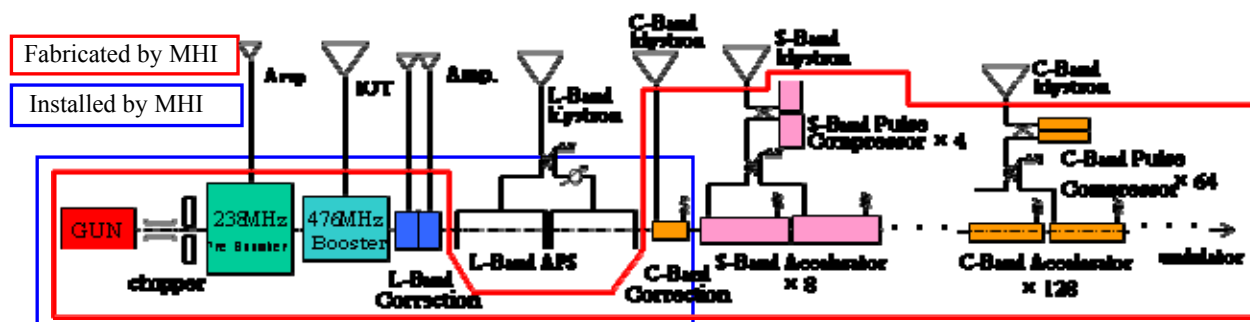

Figure 1 : Linac outline of XFEL project

C-BAND CHOKE MODE ACCELERATING STRUCTURE

The C-band choke mode accelerating structure accelerates the electron beam by propagating a high-power microwave in the accelerating structure (Refer to Fig. 2). It is designed to damp the higher order modes.

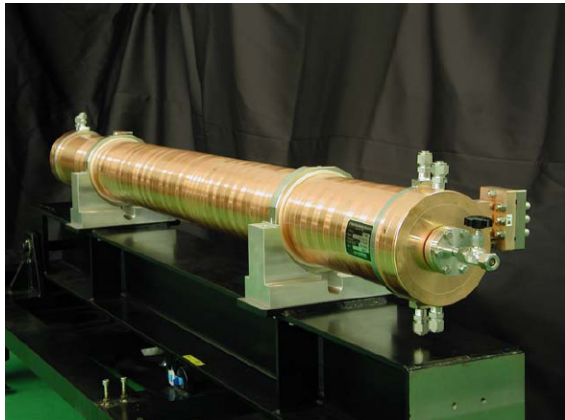

Figure 2 : C-band choke mode accelerating structure

The C-band choke mode accelerating structure is composed of 89 cells and 2 coupler cells. The frequency of these cells are adjusted by the precision machining (Refer to Fig. 3). And surface roughness of these cells are suppressed to 0.1 μ m or less by the precision machining. After precision machining, the SiC is press-fit to the cell for damping the higher order modes (Refer to Fig.4). And all cells are assembled by brazing. After brazing, the RF measurement is executed in the clean room.

Table 1 shows the specifications of the C-band choke mode accelerating structure.



Figure 3: precision machining. Figure 4: cell with SiC.

Table 1: Specifications of C-band Choke Mode Accelerating Structure

Resonance Frequency	5,712 MHz(30°C in vacuum)
Phase Shift	$3\pi/4$
Accelerator Type	Quasi- C.G.
Number of Cells	89+2 coupler cell
Quality Factor	10,200~9,900
Group Velocity	0.031c~0.013c
Shunt Impedance	49.3~60.0 M Ω /m
Attenuation Constant (τ)	0.53
Filling Time	296 ns

C-BAND RF PULSE COMPRESSOR

The C-Band RF pulse compressor is composed of resonance cavity, mode converter[4], and 3dB coupler (Refer to Figure 5). The RF output from the klystron is distributed to half (3dB) for two resonance cavities with 3dB coupler.

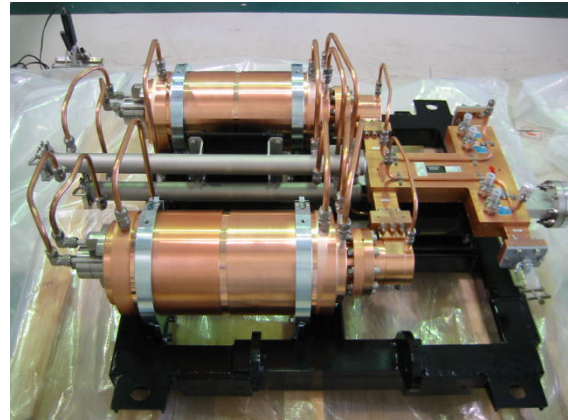

Figure 5 : C-band RF pulse compressor

Q_0 of the pulse compressor should be very high (>180,000) to compress the RF output from the klystron into high peak power. It is demanded that the resonance frequency error margin of cavities be 10kHz or less. The tuner to adjust the frequency is installed on resonance cavities. The resolution of the tuner is 1 μ m or less. Q_0 of the pulse compressor is stably obtained to be 180,000 or more (Refer to Fig. 6).

Table 2 shows the specifications of the pulse compressor.

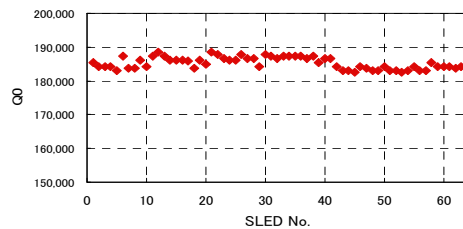

Figure 6 : Q_0 measurement for all units.

Table 2: Specifications of C-band RF Pulse Compressor

Composition	Resonant cavity $\times 2$, mode converter $\times 2$ 3-dB coupler $\times 1$
Material	OFC-CLASS1&2 SUS304, SS400
RF Flange	A-DESY type
Resonance Frequency	5,712 MHz (30°C in vacuum)
RF mode	TE 0 ₁ , 1 ₅
Quality Factor (Q_0)	$\geq 180,000$
Coupling Factor (β)	8
VSWR	≤ 1.10
RF Power	input: 50 MW pulse width: 2.5 μ s, repetition: 60 Hz
Tuning Mechanism	Diaphragm structure with differential screw
3-dB coupler	3dB coupler: coupling 3dB, isolation ≥ 25 dB RF monitor: coupling 60dB, isolation ≥ 25 dB

OUTPUT OF HIGH POWER RF TEST

Figure 7 shows the result of high power RF test of C-band acceleration unit including pulse compressor at RIKEN. The RF output of the pulse compressor is 280MW in peak value by klystron RF output power 48MW, and the acceleration gradient of the accelerating structure reached 42MV/m (design parameter 35MV/m is satisfied enough).

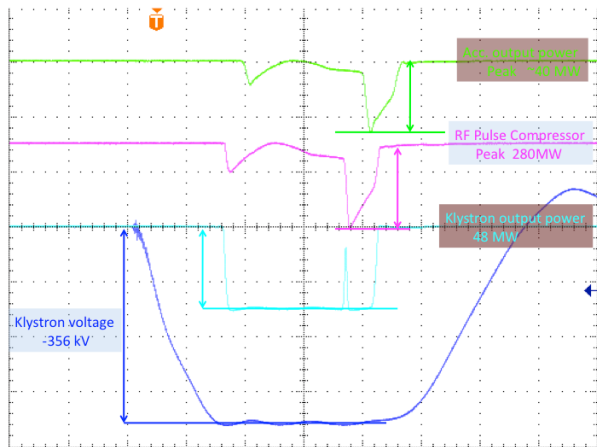

Figure 7 : Results of high power RF test at RIKEN

MASS PRODUCTION

Figure 8 shows the mass production situation of C-band choke mode accelerating structure and RF pulse compressor. As above mentioned, the fabrication and RF adjustment of all units have been completed. (C-band choke mode accelerating structure×128, C-band RF pulse compressor×64)

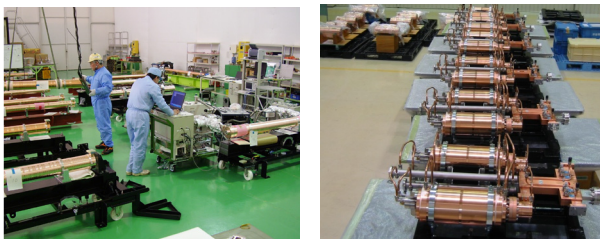

Figure 8: Mass production of C-band choke mode accelerating structure and RF pulse compressor.

INSTALLATION

Installation of C-band choke mode accelerating structure and RF Pulse Compressor has been completed by Riken. (August,2009 ~ July,2010, Refer to Fig.9) There are 128 units of C-band choke mode accelerating structure and 64 units of RF Pulse Compressor.

And installation of injector section has been completed by MHI (May, 2010~July, 2010, Refer to Fig. 10).



Figure 9: Installation of C-band section (by RIKEN).

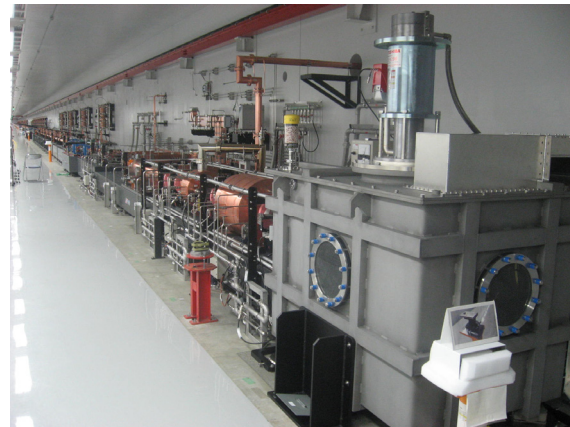

Figure 10: Installation of injector section (by MHI).

CONCLUSION

- Mass production of the 128 C-band choke mode accelerating structure, 64 RF pulse compressor and 64 units of waveguide components has been completed.
- A high-power examination was conducted in the test stand at RIKEN. The RF output of the pulse compressor is 280 MW in peak value, and the acceleration gradient of the accelerating structure is achieved to be 42 MV/m.
- The commissioning team succeeded in the XFEL laser oscillation of 0.8 Å wavelength. Now the accelerator is stably operated for the XFEL commissioning.

REFERENCES

- [1] <http://www.riken.jp/XFEL/>
- [2] T. Shintake et al., "Status of SCSS X-FEL project at RIKEN/SPring-8", Proceedings of 2nd Annual Meeting of Particle Accelerator Society of Japan, 2005.
- [3] S. Miura et al., "Mass Production of C-Band Accelerator System", Proceedings of the 5th Annual Meeting of Particle Accelerator Society of Japan, 2008.
- [4] T. Shintake et al., "Development of C-band RF Pulse Compression System for e+e- Linear Collider", Proceedings of PAC97